



ETIP SNET

EUROPEAN
TECHNOLOGY AND
INNOVATION
PLATFORM

SMART
NETWORKS FOR
ENERGY
TRANSITION

PLAN.
INNOVATE.
ENGAGE.



WHITE PAPER

Holistic architectures for future power systems

March 2019



ETIP-SNET Definition:

*A **holistic power system architecture** is an architecture in which all relevant components of the power system are merged into one single structure. These components could comprise of the following:*

- **Electricity producer** (regardless of technology or size, e.g. big power plants, distributed generations, etc.),
- **Electricity storage** (regardless of technology or size, e.g. pumped power plants, batteries, etc.),
- **Electricity grid** (regardless of voltage level, e.g. high-, medium- and low voltage grid),
- **Customer plants, and**
- **Electricity market**

The holistic architecture unifies all interactions within the power system itself, between the network-, generation- and storage operators, consumers and prosumers, and the market, thus creating the possibility to harmonise them without compromising data privacy and cyber security. It facilitates all processes which are necessary for a reliable, economic and environmental friendly operation of smart power systems. It allows a clear description of the relationships between different actors. It creates conditions to go through the transition phase without causing problems.



INDEX

1. EXECUTIVE SUMMARY	3
2. THE NEED FOR A HOLISTIC ARCHITECTURE FOR FUTURE POWER SYSTEMS	5
3. WEB OF CELLS CONCEPT	7
4. IDE4L HIERARCHICAL AND DISTRIBUTED ARCHITECTURE	9
5. SMARTNET ARCHITECTURE	12
6. <i>LINK</i> -BASED HOLISTIC ARCHITECTURE	14
GLOSSARY	16
APPENDICES – ADDITIONAL INFORMATION	17
A - WEB OF CELLS ARCHITECTURE	18
1. TECHNICAL AND MARKET HOLISTIC MODEL	18
2. HOLISTIC ARCHITECTURE	19
3. DATA PRIVACY AND CYBER SECURITY	19
4. APPLICABILITY AND REPRODUCIBILITY	21
B - THE IDE4L ARCHITECTURE	22
1. TECHNICAL AND MARKET HOLISTIC MODEL	22
2. HIERARCHICAL DISTRIBUTION AUTOMATION CONCEPT	25
3. DATA PRIVACY AND CYBER SECURITY	26
4. APPLICABILITY AND REPRODUCIBILITY	26
C - SMARTNET ARCHITECTURE	27
1. COORDINATION SCHEMES	27
2. APPLICABILITY AND REPRODUCIBILITY	28
D - <i>LINK</i> -BASED HOLISTIC ARCHITECTURE	30
1. HOLISTIC MODEL AND ARCHITECTURE	30
2. RELATION BETWEEN AUTOMATION AND DIGITALISATION	36
3. <i>LINK</i> -ECONOMICS	37
4. IMPLEMENTATION STRUCTURE	38
5. TECHNICAL DETAILS	39

1. EXECUTIVE SUMMARY

Cost effective and secure transition to lower carbon electricity system will require fundamental transformation of the power system control from traditional centralised to a decentralised paradigm. This fundamental change will require development of novel architectures that can reliably meet the needs of the emerging power system. One of the key tasks associated with the new emerging architectures is to enhance the controllability associated with future power system operation in order to enhance the infrastructure utilisation while cost-effectively managing security and resilience. In this context, this White Paper sets out the holistic architecture vision that should inform future demonstration projects that would enable large-scale rollout of the new control paradigms.

In this context, some European projects that are addressing some of the emerging challenges are discussed, in the context of the long-term holistic architectures vision for future power systems which is the core focus of the White Paper.

Concepts from the ELECTRA IRP, IDE4L, SmartNet (TSO-DSO Coordination) and ZUQDE projects are presented. These European projects are addressing similar challenges and at a system-wide level, from the transmission and distributions systems to the customer. Some of these approaches are based on upgrading the existing architecture (SmartNet and IDE4L). Whereas others propose fundamental change to the architecture (Web of Cells and *LINK-Solution*) to provide a network of decentralised systems with local autonomy over managing the optimal utilisation of available resources to reliably meeting the needs of the new power system that have arisen.

The [Web of Cells](#) concept was developed within the European project ELECTRA IRP (European Liaison on Electricity Committed Towards long-term Research Activity Integrated Research Program) provides a decentralised control using non-overlapping geographical areas of the power system, known as cells, to maximise the utilisation of renewable sources. The main assumption that motivated the development of WoC constitutes that the future power system will be highly decentralised and with high share of renewable resources at distribution system level. The decentralised control concept will effectively address local problems locally, whereby each cell will be making optimal use of the flexibility resources within its boundaries, thereby contributing to effective voltage and frequency control in the entire power system. WoC needs to enhance the research efforts with specific attention to cyber-security and data integrity.

Within the [IDE4L](#) project, a concept is developed based on existing power system infrastructure and systems for communications, control and automation. The architecture designed is based on monitoring, control, and business use cases and using the Smart Grid Architecture Model (SGAM) formulation. The European Commission mandate M/490 standardised the SGAM framework for definition of architectures for smart grids. In order to facilitate the integration of renewable generation and new customers, the IDE4L architecture enhances observability and controllability of the distribution networks and, therefore, enables more cost-efficient operation of the whole power system. However, further investigation is needed to ensure data privacy and cybersecurity.

A concept based on TSO-DSO coordination was developed in the H2020 project [SmartNet](#). This examines the implementation of a flexibility market to provide optimised instruments and modalities to improve the coordination between the grid operators at national and local level (respectively the TSOs and DSOs). It also makes provision for the exchange of information for monitoring and for the acquisition of ancillary services (reserve and balancing, voltage balancing control, congestion management) from assets located in the distribution segment (flexible load and distributed generation). Five different coordination schemes were developed and evaluated within the project. The approaches developed in the Smartnet project for TSO-

DSO coordination, focussing on market based solutions, are being further developed in the H2020 projects Coordinet and Interfaces. These project will evaluate an EU-wide implementation of a selected coordination scheme. SmartNet is not looking into a completely new system which will change fundamentally the roles, functions of the existing actors.

The [LINK-based holistic architecture](#) reorganises the management of the grid, electricity production, energy storage facilities and consumers by dividing the whole system into clearly defined units "Links", each with its own control system and well-defined interfaces to their neighbouring units and the market. *LINK*-Paradigm has facilitated the design of this architecture, enabling a large scale implementation of distributed energy resources. The *LINK*-based holistic architecture considers the entire power system from high, medium to low voltage levels, including customer plants and the market. Additionally, it facilitates the description of all power system operation processes such as load - generation balance, voltage assessment, dynamic security processes, price and emergency driven demand response, etc. To overcome data privacy and cyber security challenges, the distributed *LINK*-based architecture is chosen. Its key principle is to prohibit access to all resources by default, allowing access only to a minimum of data. The straightforwardness of *LINK*-Solution is related to its standardised structures. However, it is important to proof the concept on-site by implementing the full holistic architecture. This will highlight its strengths and help to formulate concrete steps for its large scale implementation.

In conclusion, it is defined that a holistic architecture includes all electrical equipment, customer plants and the market, and through their automation and the use of information and communication technologies it enables the execution of all operational processes that are necessary for a reliable, safe and economical smart power system operation. That is, to enable a reliable and cost-efficient future power system, the whole system consisting of electrical components and their automation, ICT systems and different markets needs to be studied as a large single entity. Optimising individual functionalities or taking the viewpoint of individual actors may lead to suboptimal solutions.

2. THE NEED FOR A HOLISTIC ARCHITECTURE FOR FUTURE POWER SYSTEMS

The main driver for the evolution of power systems has been the goal of protecting the environment, which is being expressed through the global push for decarbonisation that has resulted in a significant increase in the penetration of renewables. This process has led to the transformation of the power system from its traditional centralised form to a decentralised form characterising numerous generating units of various sizes connected across the grid at different voltage levels. This fundamental change in the electricity supply structure renders the traditional technical / functional architecture no longer sufficient, thereby paving the way for the establishment of novel architectures that can reliably meet the needs of the new power system era that have arisen.

In this new paradigm, the increased penetration of renewable energy sources, such as wind and solar, poses significant challenges in the fulfilment of daily power requirements. In fact, a principal effect of this increased penetration of renewables has been the growth of uncertainty related to power systems. Specifically, renewable sources of energy are characterised by both uncertain operation and uncertain deployment patterns. The uncertain operation is related to the fact that renewable sources of energy are by default intermittent and less predictable. The uncertain deployment patterns refer to the fact that system planners do not typically know with certainty in advance how much and at which specific locations in the system renewable capacity will connect given that its deployment at residential level typically does not require prior notice of the distribution network operators.

Within this uncertainty setting power systems have tried to adapt so as to continue to deliver safe and reliable operation. This adaptation can be realised through the development and deployment of smart grid technologies. Examples of such technologies include the energy storage, demand side response and power-electronics-based assets such as soft-open points etc. All of these technologies can operate in combination with each other only in context of a holistic architecture; the description of such architectures forms the core of this paper.

One of the main tasks associated with the new architectures is to enhance the controllability associated with power system operation. Enhanced controllability can yield considerable benefits for the system and can assist in addressing a significant set of risks pertaining to the operation of smart technologies. Such benefits can be realised through the holistic architecture concept, known as holistic architecture, via the synergic utilisation of smart technologies that is achieved as a response to actual system needs. It is essential to note that the holistic architectures need to safeguard the power system from cyber threats that have the potential of causing considerable damage both structural and operational. In this context, the decentralisation of the power system should be wisely conducted to further enhance the supply resilience against natural and malicious intervention while improving reliability and minimising system costs. Additionally, it should cater for data privacy concerns by establishing transparency in the use of private data. In this context, the General Data Protection Regulation (GDPR), EU 2016/679 of the European Parliament and of the Council of 27 April 2016, sets the rules concerning data protection and privacy for all individuals within the European Union and the European Economic Area. Data exchange between the different players involved within the holistic architecture must comply with GDPR's provisions.

Although the electricity markets are undergoing a radical change, the current redispatch process for congestion management is still costly and is driving the transmission grid operation to its limits. The transformation of resource mix of fossil fuels to renewables and the rise of distributed generation calls for a radical review of the market rules under a holistic view of the power grid, customer plants and the market.



Smart grids brings into play new operation processes like Demand Side Response (DSR), observation of Dynamic Line Rating (DLR), Active Power Curtailment (APC) of the output of a renewable generating unit, Coordinated Voltage Control (CVC), Energy Storage (ES), Soft Open Point (SOP) that allow the dynamic control of power flows through lines, expansion of the monitoring process at distribution level, Distribution State Estimator (DSE), etc. Actually, the technologies developed to support these processes do not allow for a broad coordination as they are not developed in the same framework. In many cases, their effective use is limited.

To overcome the issues discussed above, the holistic power system architectures are presented in this paper as a way to decarbonise the electricity power industry in a cost-effective manner through adopting advanced technologies that add value to utilities and consumers alike while at the same time respecting data privacy and guaranteeing safety against external threats.

3. WEB OF CELLS CONCEPT

The Web of Cells (WoC) is a new power grid control architecture that was proposed and developed within the ELECTRA IRP¹ (European Liaison on Electricity Committed Towards long-term Research Activity, Integrated Research Program) and allows for decentralised control. This scheme has been proven to be feasible through a series of simulations and lab experiments that have been conducted within the framework of ELECTRA IRP.

The main assumption that motivated the development of WoC constitutes that the future power system is highly decentralised and with high share of renewable resources at distribution system level.

In such a future power system, the frequency and voltage control may no longer be effectively managed centrally by Transmission System Operators (TSOs), which is the business-as-usual case, unless there are monitoring systems and ubiquitous sensors deployed across the grid that will be able to collect all necessary information at LV and MV levels and then transmit it to the TSO for further analysis. This analysis will allow for the detection of local problems that will then determine the need to activate reserves (flexible resources). In this context, achieving full network visibility may involve prohibitively high costs to cover for a system-wide deployed ICT control and monitoring system, especially given the big data generated by Distributed Energy Resources (DER) spread across the grid. Hence, ELECTRA IRP proposed the WoC on the idea that a decentralised control concept will most effectively address local problems locally.

In fact, ELECTRA IRP proposed the WoC concept given the emergence of the decentralised electricity supply paradigm and the following key trends:

- Generation will shift from classical dispatchable units to intermittent Renewables;
- Generation will shift from relatively few large units to many smaller ones, mainly connected at distribution level. Decentralisation will be supported also by the developments in information and communication technologies as well as by machine learning algorithms and big data techniques. It is expected that even the last mile of the power system is about to be covered by ICT;
- There will be more deviations compared to what was planned as well as incidents (e.g. generation outages);
- Greater power injection at LV and MV levels will increase the risk of local voltage problems and congestion. Thus resources that can address voltage and balancing problems will move to a large extent from transmission system level (HV) to distribution level (MV, LV);
- Availability of resources (e.g. production and storage) may vary significantly across different geographical locations. This availability will increase mainly at distribution system level;
- Electricity consumption will increase significantly given the drive towards electrification of transport and heating/ cooling. Much of the load will be controllable/responsive to market signals, making local consumption-forecasting even more challenging;
- Energy storage will be a cost-effective solution for offering ancillary services. Distributed ES will become a competitive solution compared to traditional resources for reserves;
- In such a future power system, coordination between operators of different voltage levels will be essential given that central TSOs will no longer have the system overview to effectively dispatch reserves

According to the WoC concept the power system operation is split into a number of connected

¹ ELECTRA IRP project funded under FP7 by the European Commission

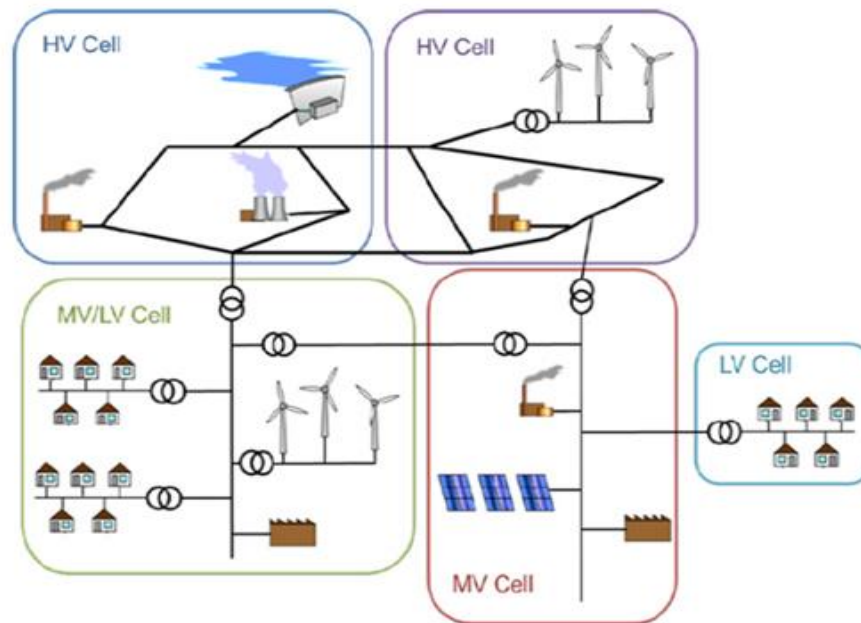

Figure 1: Schematic diagram of a power system split in cells of different voltage levels.

entities located in non-overlapping geographical areas of the power system and are known as 'control cells', with each one having the possibility of containing multiple voltage levels. Since the cells are non-overlapping subsets of the power system topology, the union of their topology is equal to the topology of the power system. Figure 1 illustrates this concept.

CONSIDERATIONS

The WoC² is a new power grid control architecture that was proposed and developed within the ELECTRA IRP and has been proven to be feasible through a series of simulations and lab experiments that have been conducted within the framework of ELECTRA IRP. The main assumption that motivated the development of WoC constitutes that the future power system will be highly decentralised and with high share of renewable resources at distribution system level.

In such a decentralised power system, the business-as-usual case of centralised control will lead to prohibitively high costs given that effective grid monitoring and control will require deployment of monitoring systems and ubiquitous sensors across the grid for collection and analysis of massive amounts of data (big data). On the other hand, WoC rests on the idea that a decentralised control concept will effectively address local problems locally, whereby each cell will be making optimal use of the flexibility resources within its boundaries, thereby contributing to effective voltage and frequency control in the entire power system.

In [conclusion ETIP-SNET](#) considers WoC as a holistic architecture that is specifically developed for addressing the challenges related to a future highly decentralised power system with large share of renewable resources. Firstly, WoC has been proven technologically feasible through simulations and laboratory experiments. Secondly, it has the potential to effectively manage the flexible resources spread across the network, in a decentralised manner without the need for the deployment of system-wide monitoring and control ICT infrastructures that would potentially render the system costs prohibitively high. As a result, it is important to enhance the research efforts with specific attention to cyber-security and data integrity.

² For more details see Appendix A -

4. IDE4L HIERARCHICAL AND DISTRIBUTED ARCHITECTURE

The increasing amount of distributed intermittent generation changes the operational and planning principles of the power system drastically. The centralised operation of the system will transform towards more distributed approaches where also small DERs need to actively participate to power system operation. The IDE4L³ architecture enables utilisation of small-scale DERs for transmission and distribution system management purposes in a cost-efficient manner. The IDE4L hierarchical and distributed architecture was developed in IDE4L project.

Concept

The overview of the IDE4L automation concept is represented in Figure 2. The architecture builds on top of the existing power system infrastructure and reuses existing automation solutions such as DSO control centre IT systems (SCADA, Distribution Management System (DMS), etc.) by integrating them into the proposed architecture. Therefore, the proposed solution can be easily expanded from the existing systems.

The architecture has been designed based on monitoring, control, and business Use Cases and using the Smart Grid Architecture Model (SGAM) formulation. The European Commission mandate M/490 standardised the SGAM framework for definition of architectures for smart grids.

The automation architecture consists of automation systems owned by different power system actors as indicated in Figure 2. Distribution automation shown inside the DSO box includes control centre information systems, primary and secondary substation automation, and intelligent electronic devices (IEDs), including multiple types of devices like smart meters in

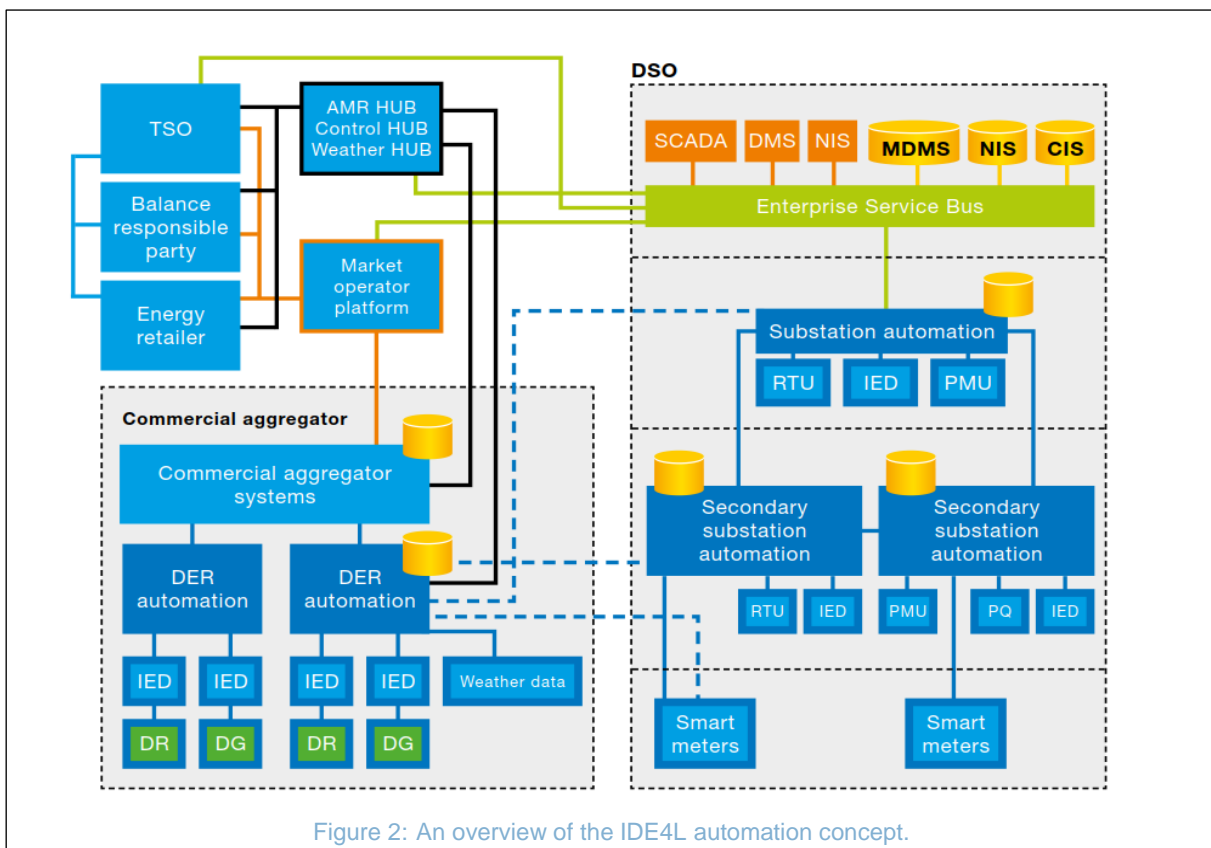

Figure 2: An overview of the IDE4L automation concept.

³ IDE4L project funded under FP7 by the European Commission

the customer interface. It realises the real-time monitoring and controlling of all MV and LV networks and direct control of DERs. Commercial aggregator automation system enables participation of DERs to different market places. In addition to the already existing markets, DERs can participate also to local DSO markets. The development of distribution automation and addition of the commercial aggregator automation system enable efficient utilisation of DERs both for transmission and for distribution system operational purposes.

The architecture has been defined in all SGAM layers (business, function, information, communication and component) and more detailed representation of the whole architecture can be found in IDE4L project deliverables and publications. The most detailed analysis have been conducted for distribution systems and aggregator systems.

The IDE4L architecture enhances observability and controllability of the distribution networks and, therefore, enables more cost-efficient operation of the whole power system. The existing systems are utilised as the starting point for the architecture development and, therefore, step-wise implementation of the new smart grid functionalities is possible.

Traditional distribution automation solutions are not rapid and scalable enough to monitor and control large-scale DERs in real time on both MV and LV networks. In the hierarchical and distributed architecture, distribution system operation is distributed such that each MV and LV network is controlled by its own automation component substation automation unit (SAU). The SAU is the main new component in the architecture and is responsible for congestion management (both voltage and current congestions) and network optimisation in real-time.

The architecture is technology neutral as far as standards are used, so it can be implemented with heterogeneous types of measurement devices, controllers, and computation units. All data exchange and modelling are based on international standards to enable interoperability, modularity, the reuse of existing automation components, and the faster integration and configuration of new automation components.

CONSIDERATIONS

In the future smart energy system, small-scale DERs need to actively participate to power system operation. The IDE4L⁴ hierarchical and distributed architecture enables utilisation of the DERs for transmission and distribution system purposes in a cost-efficient manner. The feasibility of the architecture was confirmed through simulations, lab testing and finally real network demonstrations.

IDE4L architecture builds on top of the existing power system infrastructure and can be taken into use gradually. New developments concentrate especially on distribution systems and aggregator systems but also other power system actors are taken into account. The main new automation component is the substation automation unit that will be responsible for monitoring and control of one MV or one LV network. The SAUs can be added to the network at first to locations where some problems already occur and the automation system can be extended when needed. This enables utilising the existing infrastructure efficiently and makes it easier to take the architecture into widespread real network use. The architecture utilises standard interfaces and is scalable. It was designed based on several smart grid use cases using the SGAM formulation and, therefore, has not been optimised for individual use cases but is suitable for all smart grid functionalities.

IDE4L gives a mixture of the hierarchical and distributed architecture concepts. Microgrids are used on the presented distributed architecture concept. The actual work is mostly concentrated on developing distribution automation and utilisation of small-scale DERs for both distribution and transmission system purposes. In [conclusion, ETIP SNET underlines that further](#)

⁴ For more details see Appendix [B](#) -



ETIP SNET

EUROPEAN TECHNOLOGY AND INNOVATION PLATFORM
SMART NETWORKS FOR ENERGY TRANSITION

developments in guaranteeing the data privacy and cybersecurity will distinctly increase the IDE4L relevance.

5. SMARTNET ARCHITECTURE

SmartNet⁵ project aims to provide optimised instruments and modalities to improve the coordination between the grid operators at national and local level (respectively the TSOs and DSOs) and the exchange of information for monitoring and for the acquisition of ancillary services (reserve and balancing, voltage balancing control, congestion management) from assets located in the distribution segment (flexible load and distributed generation).

As such the simulation platform develops 3 layers: physical layer, market, new players, ICT architecture layer. To evaluate the costs, 5 coordination schemes between TSOs and DSO are tested in 3 location: Italy (high penetration of hydro and real time information), Denmark (thermal inertia of the swimming pools), and Spain (flexibility from mobile telephone).

Technical and market holistic model

Five different coordination schemes: the Centralised Ancillary Services (AS) market model, the Local AS market model, the Shared Balancing Responsibility model, the Common TSO-DSO market model and the Integrated Flexibility market model. **Error! Reference source not found.** below illustrates the five coordination schemes.

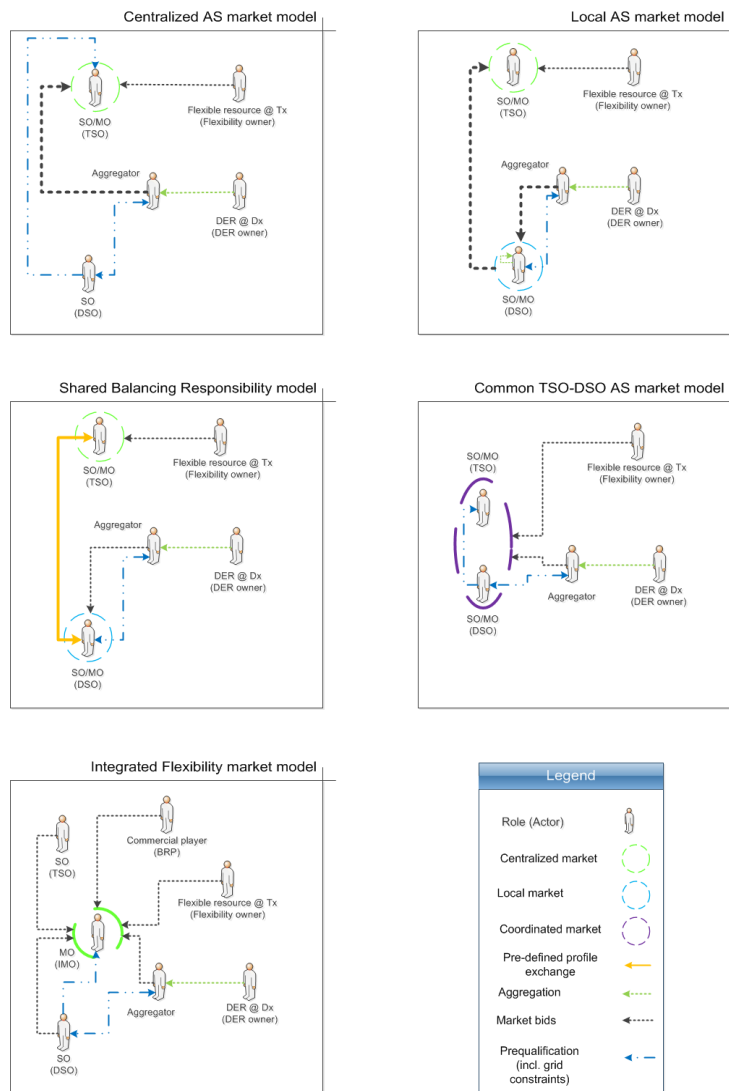

Figure 3: Illustration of five coordination schemes.

⁵ SmartNet project funded under H2020 by the European Commission

The coordination schemes between TSOs and DSOs is mainly related to network planning, common data platforms or sharing of metering data. Although in most countries, DER units can provide flexibility-based services, there is still a wide heterogeneity in products and rules across countries.

A coordination scheme is defined as the relation between TSO and DSO, defining the roles and responsibilities of each system operator, when procuring and using system services provided by the distribution grid. The design of the market to procure system services will depend on the relation between system operators and the roles they will take up. A role is defined as an intended behaviour of a specific market party, with certain responsibilities, which is unique and cannot be shared

Depending on the coordination scheme, certain roles of system operators might be added, extended, modified or shifted.

Considerations

The SmartNet⁶ project is a market place platform which defines 5 options for ancillary services market models and defines the roles of the DSOs and also TSOs in the different market places schemes. It takes into account the distribution grid constrains. It also defines ICT architecture which enables the 5 coordination schemes and the exchange of information. By looking into ancillary services market and the activation of the distributed resources such as swimming pools, PV installation etc. is taking into account the customer/prosumer.

In conclusion, ETIP SNET underlines that **SmartNet is not looking into a completely new system which will change fundamentally the roles, functions of the existing actors.**

⁶ For more details see Appendix [C](#) -

6. LINK-BASED HOLISTIC ARCHITECTURE

The foundations of the *LINK*-based holistic architecture have emerged from the FENIX⁷ and ZUQDE⁸ projects. The concept of secondary control as a sustainable, resilient, base interaction instrument is realised in a reduced scope. It is successfully implemented in open-loop during the FENIX project, and in closed-loop during the *ZUQDE*-project. There are made the first steps of the architectural design. Whereas, the *LINK*-Paradigm is derived from the Smart Grid fractal pattern developed as part of an internal project of the TU Wien, Austria.

LINK-the smart grid paradigm

The *LINK*-based holistic architecture addresses the decarbonisation of power industry by preserving data privacy and cyber security. The already very complex operation processes of the power systems are becoming even more complex and unclear as a result of the DER penetration, and the latest renewable energy resources with very high volatility. Therefore, to understand and design the highly complex operation processes of the future power systems, the smart grid paradigm “*LINK*” shown in Figure 4 is defined as follows:

LINK-Paradigm is defined as a set of one or more electrical appliances - i.e. a grid part, a storage or a producer device -, the controlling schema and the interface.



Figure 4: *LINK*-paradigm

LINK-Paradigm is used as an instrument to design the *LINK*-based holistic architecture. It facilitates the modelling of the entire power system from high, medium to low voltage levels, including customer plants and the description of all power system operation processes such as load - generation balance, voltage assessment, dynamic security, price and emergency driven demand response, etc. *LINK*-Paradigm is the fundament of the holistic, technical and market-related model of smart power systems with large DER share, Figure 5.

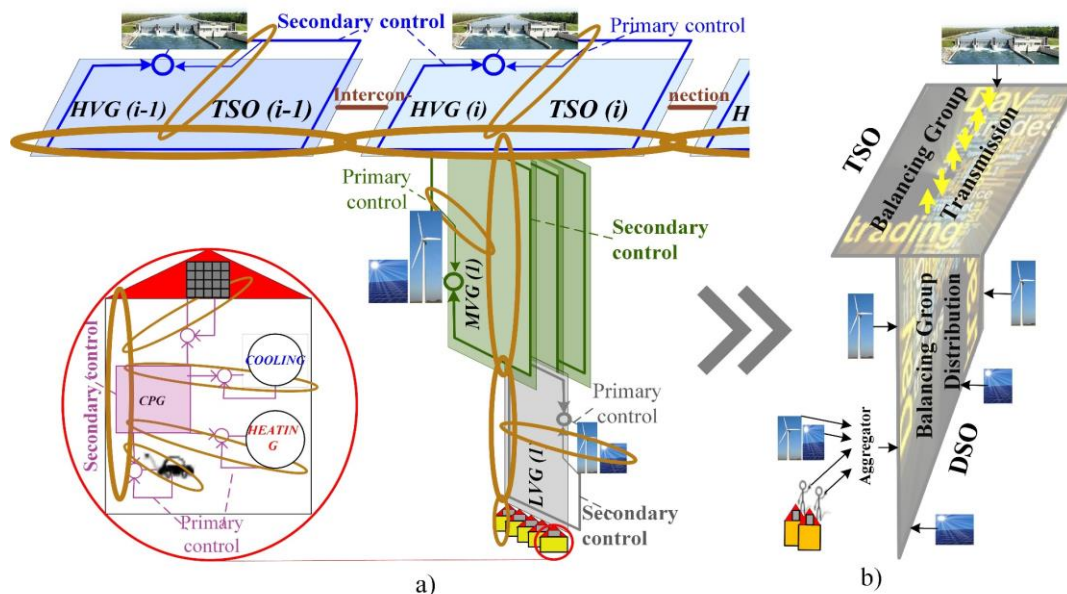

HVG-High Voltage Grid; MVG-Medium Voltage Grid; LVG-Low Voltage Grid; CPG-Customer Plant Grid.

Figure 5: Overview of the holistic model: a) technical: the “Energy Supply Chain Net” and b) market-related.

⁷ FENIX project funded under FP6 by the European Commission

⁸ ZUQDE project funded by “Neue Energien 2020” of “Klima- und Energiefonds”, Austria.

LINK-Paradigm reorganises the management of the grid, electricity production, energy storage facilities and consumers by dividing the whole system into clearly defined units, "Links", each with its own control system and well-defined interfaces to their neighbouring units and the market.

Holistic architecture

Figure 6 shows the *LINK*-based holistic architecture, where all relevant components of the power system are merged into one single structure. The electricity producers and storages are considered regardless of technology and size; the power grid is considered regardless of voltage level; all customer plants and the electricity market are taken into account.

The basis of the *LINK*-Economics is the functioning of available advanced technologies of management systems and optimal investment. The accumulated knowledge and the available technologies for the operation of power systems is useful to *LINK*-Solution. However, it has some unique aspects that require innovations. New online and real time applications will be designed and developed to ensure reliable and resilient operation through the dynamic optimisation in each Link.

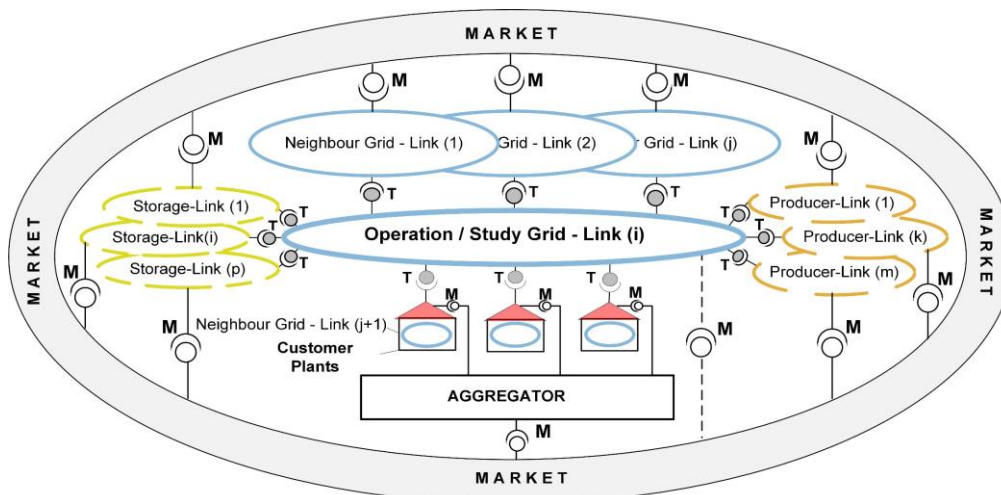

Figure 6: Overview of the *LINK*-based holistic architecture.

Considerations

During ZUQDE project a small part of the *LINK*-based holistic architecture⁹ is successfully implemented and proofed on field. The main purpose of designing this architecture is the large scale DER integration, guaranteeing data privacy and cyber security. The *LINK*-Paradigm allows the design of a straightforward holistic architecture with standardised structures. The data needed to be exchanged to achieve a reliable, economic and environmental-friendly power supply are minimised and well defined. All processes that are needed to successfully operate the future power system are considered. The *LINK*-based holistic architecture accommodates the LECs, guaranteeing the fair market participation of all stakeholders without compromising the secure, economic and the environmental-friendly supply of electricity.

In **conclusion, ETIP SNET** finds that the *LINK*-based holistic architecture is **comprehensive and promising**. However, on-site some basics are realised on a reduced scope. Therefore, it is important to proof the concept on-site by implementing the full holistic architecture. This will highlight its strengths and help to formulate concrete steps for its large scale implementation.

⁹ For more details see Appendix [D](#) -

GLOSSARY

Automatic is having the capability of starting, operating, moving, etc., independently.

Automation is the technique, method, or system of operating or controlling a process by highly automatic means, as by electronic devices, reducing intervention to a minimum. (British Dictionary; <https://www.dictionary.com/browse/automation?s=t>)

Digitisation is the process of transcribing data into a digital form (0, 1) so that it can be directly processed by a computer.

Digitalisation is the process of moving to a digital business that is using digital technologies to change business models and provide new revenue streams and value producing opportunities.

Paradigm is a symbolic model or diagram that makes it easier for us to understand the essential characteristics of a complicated process.

Smart City is a developed urban area that creates sustainable economic development and high quality of life by excelling in multiple key areas; economy, mobility, environment, people, living, and government.



ETIP SNET

EUROPEAN TECHNOLOGY AND INNOVATION PLATFORM
SMART NETWORKS FOR ENERGY TRANSITION

APPENDICES – ADDITIONAL INFORMATION

A - WEB OF CELLS ARCHITECTURE

1. Technical and market holistic model

Specifically, an ELECTRA cell, as it is called, is a portion of the power grid that is able to maintain an agreed power exchange at its boundaries by using the internal flexibility available from flexible resources such as flexible generators, flexible loads and energy storage. The total internal flexibility must be at least enough to compensate the cell generation and load uncertainties in normal operation. This way, a cell can

- provide real-time frequency (balancing) services;
- voltage services to the power system.

Hence, a cell can contribute to correcting real-time imbalances (thus frequency deviations) caused by forecast errors (in load or generation) i.e. deviations from the scheduled balance or incidents such as outages. This way, voltage and frequency (balancing) control is ensured in the future power system and through the use of flexibility resources, WoC concept contributes to the fundamental development of local energy markets for system ancillary services.

Note that a cell does not have a standardised size. Rather, its size is determined by the needs of the system at hand and the available flexibility resources. Also, it is not required that a cell is self-sufficient and able to balance internal generation and load. However, this case is possible i.e. if a cell has only one connection point with the rest of the system and with enough resources to be self-sufficient, then it will be able to operate in both grid-connected and island modes.

Notice that each cell is managed by a Cell Controller (CC), which is under the responsibility of a Cell System Operator (CSO). The latter can operate many cells and essentially includes functions and services conventionally provided by DNOs, DSOs and TSOs. Also, it has the responsibility of intervening in the operation of one or more cells in the case that any emergency situation occurs. Regarding the Cell Controller, it can interact with neighbouring cells so as to mutually agree on selecting set-points for critical parameters in order to rapidly restore normal operation.

Such control structure allows for high interconnection capabilities, with cells being connected to each other via physical tie-lines that may have meshed or radial topology. This interconnection allows neighbouring cells to support each other in an autonomous distributed collaborative manner based on local observables (peer to peer imbalance netting).

Through the use of advanced control methodologies, local disturbances that may occur within the boundaries of a cell can be contained so that they have negligible effect on the overall operation of the power system. In other words, it is possible to achieve very limited propagation of local disturbances across the entire power system. Hence, the WoC concept can contribute to a stable and reliable power system operation.

WoC is designed for market integration. Specifically, the CSO procures the capacity reserves in the markets of balancing and voltage control services. Specifically, the CSO buys inertia capacity, balancing capacity and reactive power products from Balance Service Providers (BSPs) and activate them in real-time when necessary i.e. when there is a cell imbalance or voltage problem. The procurement of balancing services by each CSO is performed via organised marketplaces (exchange), using a common platform developed at the WoC level. This platform employs an auction as a mechanism for efficient allocation of resources and efficient pricing of inertia, balancing and voltage control services. Then, the auction is cleared based on price of bids submitted by the BSPs to the capacity markets open separately for each cell by the corresponding CSO. This way, a market clearing price for all BSPs in the cell is established, and based on this price, the CSO will then remunerate BSPs for availability of capacity of inertia, balancing capacity and reactive power capacity.

2. Holistic architecture

The WoC architecture is a holistic architecture characterised by the implementation of six high-level functionalities. These functionalities solve local problems locally, allow collaboration with neighbouring cells, while ensuring rapid activation of local reserves in an optimal manner. As a result, WoC contributes to the safe and reliable operation for the entire system.

The first fundamental functionality of this architecture is the balance restoration control (BRC) functionality, which is based on the fact that cells are responsible for matching their actual net active power import/export profile with the forecasted one through the optimal use of local flexibility resources.

Furthermore, the adaptive frequency containment control functionality (FCC) allows for each cell to have a portion of frequency droop responsibility so that reserves activations are prioritised in cells that are causing deviations and are minimised in cells that are not causing them. The implementation of this functionality achieves optimally activating reserves that can contain system frequency within statutory limits.

A third fundamental functionality is the inertia response power control (IRPC) functionality that ensures that a constant inertia is provided to the system through the supply of extra synthetic inertia that will complement the physical one. This functionality is essential given the fact that the rotating mass (synchronous generating units) is expected to reduce in the future power system. This way, each cell becomes a source for inertia that will be very vital for the needs of the entire system. Further to this, the balance steering control (BSC) functionality mitigates the amount of excess reserves activations through the modification of cell power balance set points by considering neighbours of cells in a coordinated way and implementing imbalance netting.

Voltage control functionalities are also prevalent in cells' operations across all voltage levels. Primary voltage control functionality (PVC) as well as post-primary voltage control functionality (PPVC) are used to influence cells' set points and can contribute to voltage control taking into account the forecasted local grid status while ensuring that the implementation of these functionalities does not affect any neighbouring cell. Such implementation is made periodically on the basis of possible reports of voltage violations.

3. Data privacy and cyber security

A cybersecurity attack performed over a decentralised structure such as the WoC architecture is not a one-off process but can be decomposed in several attack phases. To analyse this complex process, it is important to consider the most plausible attack scenarios. According to a typical scenario, the first phase of the attack attempts to access the control network of the WoC infrastructure. Then, the second phase aims at intruding the communication network of the CC, which is vital for the harmonious system operation as it can optimise the interaction of cells and intervene for successful resolution of challenging issues during emergency periods. Thus, the compromise of this vital asset can be one of the targeted objectives of any malicious attacker.

Note that these two phases are the generic categories of steps that are required for the successful cybersecurity attack. Essentially, they consist of a number of smaller steps that are all of crucial importance. Furthermore, the two phases need to be considered in sequence, where the success of the first phase is a prerequisite for the achievement of the second phase. The specific details related to this first phase are shown in the following.

Defence mechanisms against these phases of the cybersecurity attack include host-based defences authentication and encryption of control communications (e.g. patches at both client and host level) as well as strong anti-malware software.

Cybersecurity is integrally linked to data privacy and confidentiality given that cybersecurity is a principal means of successfully managing to achieve secure data flows. Research is ongoing in the area of cybersecurity applied to decentralised concepts such as WoC architecture, which

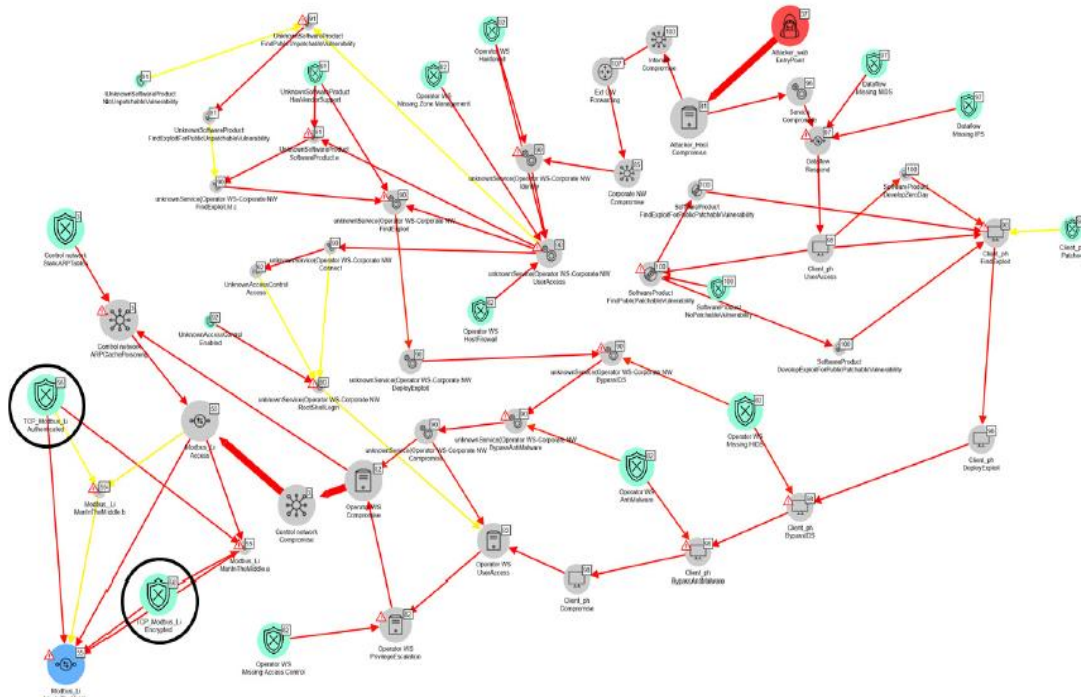

Figure 7: Diagram of paths for conducting the first phase of the cybersecurity attack against a Web of Cells infrastructure. The attacker is depicted with a red circle and the target is shown with a blue circle (Modbus communication asset, on the lower left corner of the figure). The green circles represent imperfect defence measures including Encryption and Authentication (highlighted in black), that are widely used in the protection of ICT infrastructures, yet they are not perfect against very sophisticated attacks

emphasises the strong interest in preserving data integrity and safe system operation.

One significant detail is related to the cybersecurity attack phases. The first, and primary, phase is analysed in Figure 7. It shows the possible attack paths for conducting the first phase of the cybersecurity attack.

Particularly, the first phase of the attack aims at intercepting specific data flows, without the possibility of altering the containing messages. Such interceptions can be used for information theft, spying and other intelligence gathering (e.g. collection of metadata of value to the attacker). As the above figure displays, there are multiple paths, of meshed structure, represent alternative procedures to conduct such an attack. Specific software programs are used to simulate such attack paths (e.g. securiCAD software) and identify likelihood of path success and possible imperfections.

A potentially plausible scenario includes the possibility of an attacker sending a phishing message to the victim. Following the reception and the opening of the message by the victim, a service is activated that is able to create a dataflow with the attacker. Then, the cell architecture of the Web of Cells structure becomes exposed to this dataflow. This happens because the cell architecture comprises an operator- workstation in the cell network where the operator is tricked to activate the malicious service. Then, this workstation communicates with the resources inside the cell local area network, thereby allowing the attacker to reach the control network used by the cell-controller and the resources inside the cell.

For the successful defence against the first-phase of such cyber-security attack, the focus is placed upon creating stronger authentication and integrity mechanisms tied to the Modbus data flow. Additional mechanisms are developed for the encryption of the information, where encryption may significantly reduce the possibility of eavesdrop, information theft and malicious taps into valuable metadata transmitted across the grid.

4. Applicability and reproducibility

WoC architecture constitutes a scheme towards the integration of novel decentralised control structures into the future power systems. The applicability and reproducibility of this concept is proven through extensive and systematic evaluation and test of the involved technologies, under both simulation and laboratory conditions within ELECTRA IRP.

With further testing and simulation as well as implementation, the WoC architecture may become the established solution for the future of the grid further contributing to effective decentralisation, autonomy and seamless integration of innovative technologies that augment observability and guarantee continuous supply of electricity at low cost for all.

B - THE IDE4L ARCHITECTURE

The business actors of IDE4L architecture are depicted in Figure 8 and the automation actors in Figure 9.

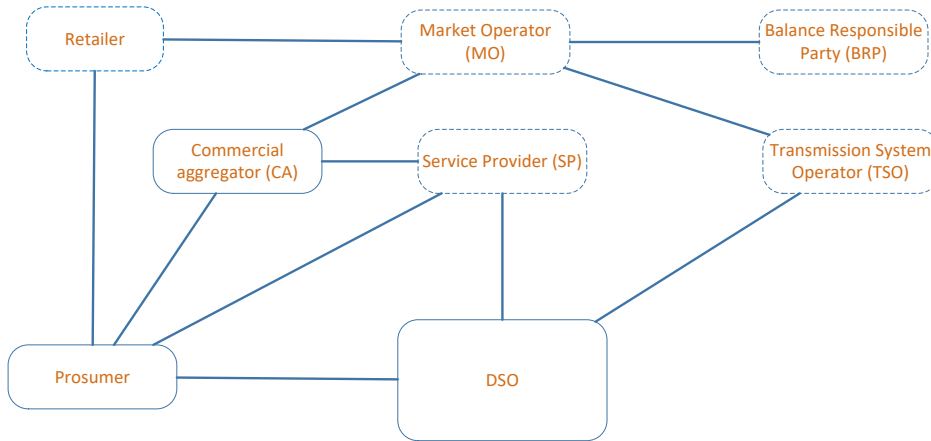

Figure 8: Business actors in IDE4L architecture.

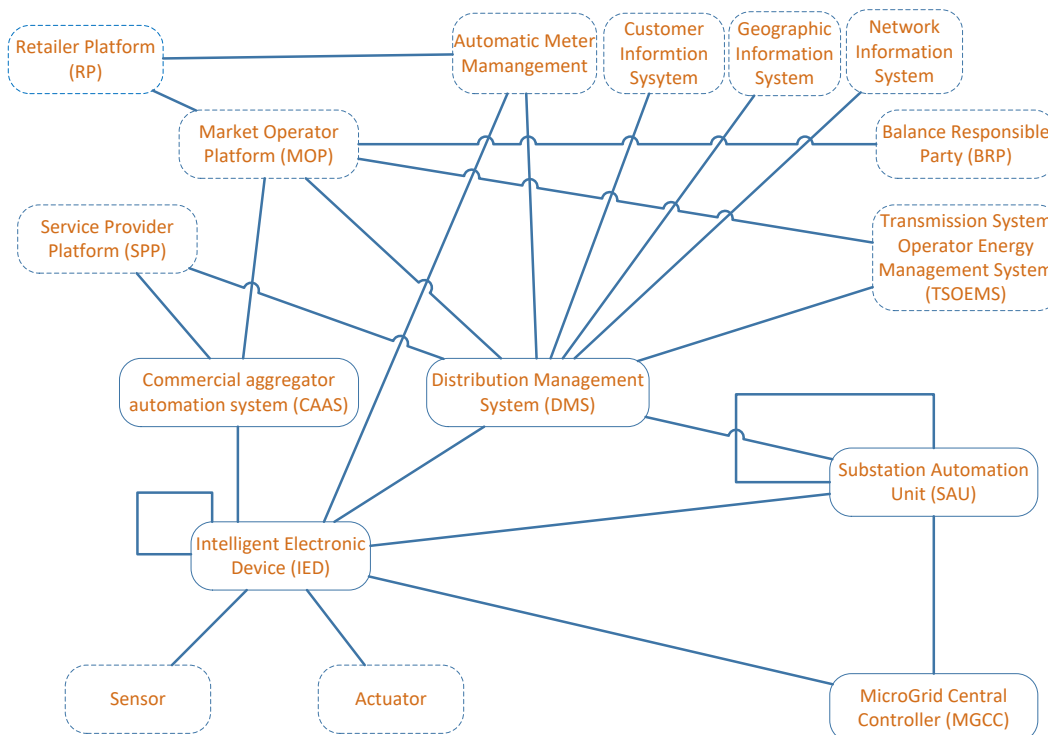

Figure 9: Automation actors in IDE4L architecture.

1. Technical and market holistic model

The IDE4L architecture enhances observability and controllability of the distribution networks and, therefore, enables more cost-efficient operation of the whole power system. The existing systems are utilised as the starting point for the architecture development and, therefore, step-wise implementation of the new smart grid functionalities is possible.

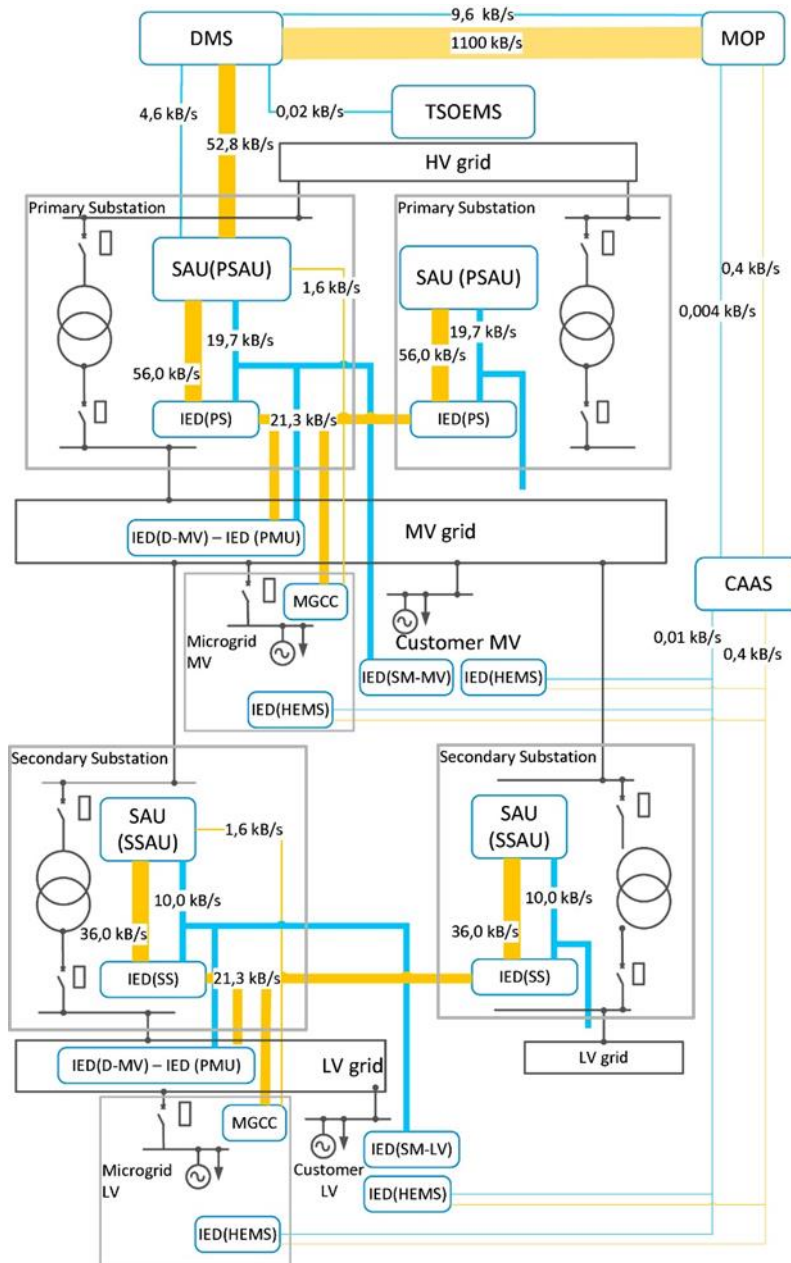

Figure 10: IDE4L architecture, with expected communication traffic.

Traditional distribution automation solutions are not rapid and scalable enough to monitor and control large-scale DERs in real time on both MV and LV networks. In the hierarchical and distributed architecture, distribution system operation is distributed such that each MV and LV network is controlled by its own automation component substation automation unit (SAU). The SAU is the main new component in the architecture and is responsible for congestion management (both voltage and current congestions) and network optimisation in real-time. Primary substation automation unit (PSAU) is responsible for monitoring and controlling of the MV network fed by the substation and, respectively, secondary substation automation unit (SSAU) takes care of the LV network downstream from it. SAUs collect measurement data from the IEDs in their network area, make control decisions based on the information and send new set points to primary controllers inside their control area. SAUs also communicate with neighbouring automation components. Only relevant information is sent which decreases the amount of information exchange compared to a centralised approach drastically. PSAU and SSAUs exchange relevant information with each other and the PSAU communicates with the control centre DMS. Communication towards other power system actors (e.g. TSO) and

market places goes through the control centre as indicated in Figure 9. Another representation of the architecture is depicted in Figure 10 which represents also expected communication traffic in an example case calculated based on the use cases that were used at the architecture definition phase and with some assumptions on the number of network nodes etc. (e.g. 250 nodes in each LV and MV network). Not all information collected from the IEDs is sent forward by the SAUs but only relevant data is transferred.

The SAUs operate near real-time. They control equipment owned by the DSO (e.g. transformer tap changers) but also customer-owned components. DER reactive power controllability can be a connection requirement or an ancillary service that the DSO purchases from the DER owner. If real power control is used by the SAU, it is either based on predefined contract that enables direct control of the DER in question or the network is in an emergency state in which case the DSO has the right to use also real power control of DERs. In normal operation conditions, real power control should happen only through a market place. In this case, the aggregator will provide the market interface to the DERs.

Also the aggregator automation system is hierarchical and decentralised as depicted in Figure 2. The first central layer is responsible for collecting and storing DER data, scheduling DERs to maximise profit, and communicating with the market operator platform for bidding and flexibility validation purposes. The second layer is DER automation, which coordinates local

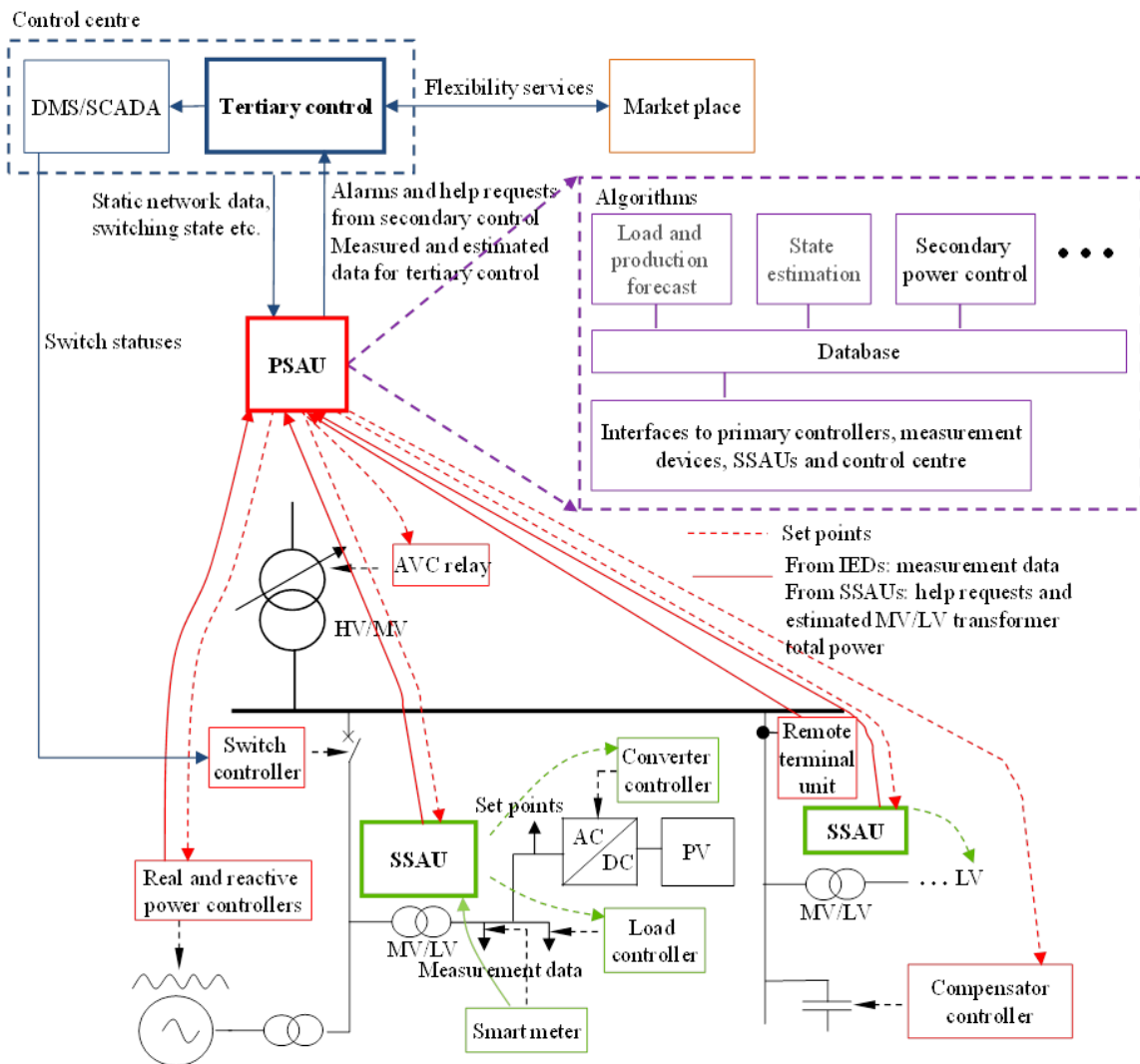

Figure 11: The distributed automation architecture and data flows between different components.

DERs and realises the activation of DER scheduling. The lowest level of the hierarchy consists of the IEDs.

The responsibilities of DSO and TSO remain in the proposed architecture similar to the current situation. DSOs are responsible for distribution network operation including voltage control, fault management etc. The operational principles, however, substantially change. Frequency control remains a system-level task and is TSOs responsibility. DERs located in distribution networks participate to frequency control through balancing markets and with the help of the aggregator. Information exchanges between different actors change and the TSO and DSO need to be more aware of each other's actions.

2. Hierarchical distribution automation concept

The distribution automation concept is hierarchical as depicted in Figure 11. Primary controllers such as automatic voltage control (AVC) relays of the transformer on-load-tap-changers (OLTCs), real and reactive power controllers of DG units, reactive power controllers of reactive power compensators and real power controllers of controllable loads are located next to the controllable resource and are the most distributed part of the control hierarchy. They operate independently based only on local measurements and, therefore, respond immediately to disturbances. The set points of primary controllers can be adjusted remotely. These devices already exist in the distribution networks, but are used with a constant set point.

Secondary controllers are located at PSAUs and SSAUs depending on which network, MV or LV, they are managing. They operate in real-time and their primary aim is to keep the network state acceptable in all loading and generation situations. As a secondary goal they aim at optimising the network state.

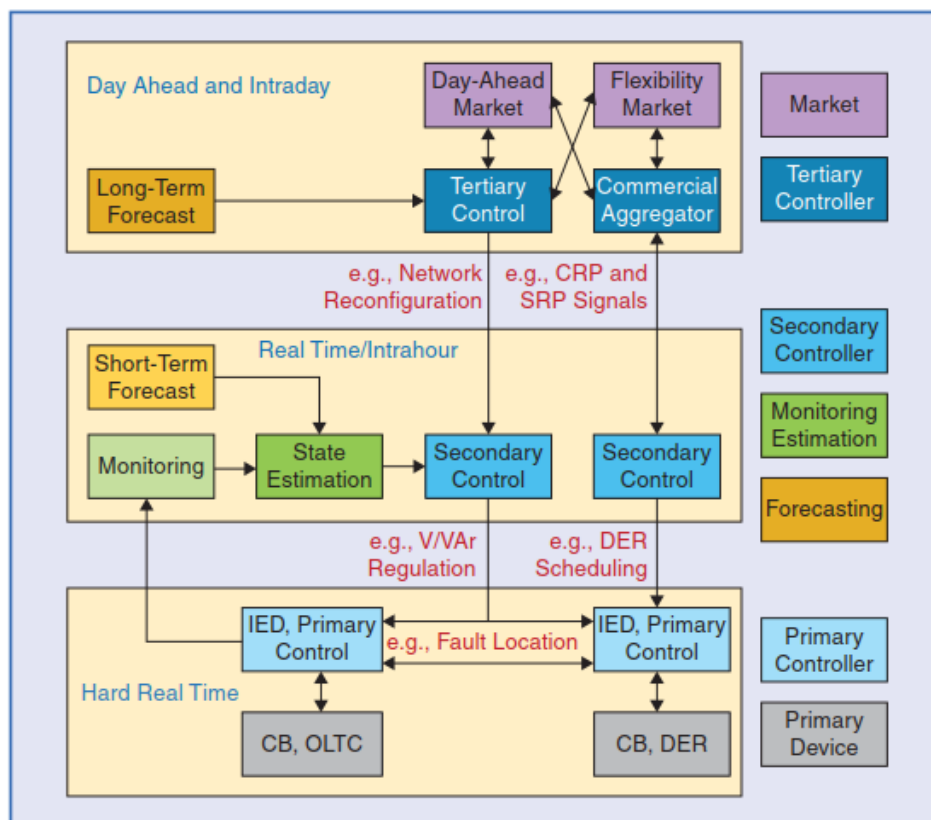

Figure 11: Hierarchical distribution automation concept

Tertiary control is located at the control centre and can be implemented as a part of the current DMS or as an individual controller. While primary and secondary controllers operate in real-time, the tertiary controller operates day-ahead based on the load and production forecasts. It has several functionalities including network reconfiguration algorithm aiming at an optimal network topology and market agent purchasing flexibility products for DSO purposes.

The hierarchy of the controllers is depicted in Figure 12.

3. Data privacy and cyber security

The distributed nature of the architecture decreases the effects of an attack to a single point in the system but, on the other hand, also provides more possible routes to interfere with the system operation. In the architecture, SAUs have a central role in system operation and, therefore, their cyber security needs to be secured.

The SSAUs collect smart meter data as an input to algorithms running on the SAU. Data privacy is very important when individual customer data is handled.

4. Applicability and reproducibility

The architecture is technology neutral as far as standards are used, so it can be implemented with heterogeneous types of measurement devices, controllers, and computation units. All data exchange and modelling are based on international standards to enable interoperability, modularity, the reuse of existing automation components, and the faster integration and configuration of new automation components. The SAU can operate on different platforms. The existing systems have been used as a starting point for architecture development and, therefore, the new smart grid functionalities can be taken into use without a need to replace the whole automation infrastructure at once.

The automation architecture has been tested first using simulations and after that in laboratory environments. The utilised laboratories have hardware-in-the-loop capabilities and, therefore, real hardware components could be used as a part of the real-time testing. Finally, the architecture was tested also in three real-world distribution network demonstration sites located in Italy, Spain and Denmark. The operation of the architecture has been evaluated based on architecture performance indicators such as profit/savings due to automation architecture. The operation of individual functionalities is evaluated using key performance indicators defined for each use case separately (e.g. root-mean-square error in state estimation use case).



C - SMARTNET ARCHITECTURE

1. Coordination schemes

The key elements used to compare the five coordination schemes developed within the SmartNet project are shown in Table 1.

Table 1			
Coordination scheme	Role of the DSO	Market organisation (market operator)	Allocation principle of flexibility from the distribution grid
Centralised AS market model	<ul style="list-style-type: none"> Limited to possible process of prequalification 	Common market (TSO)	Priority for the TSO
Local AS market model	<ul style="list-style-type: none"> Organisation of local market Buyer of flexibility for local congestion management Aggregation of resources to central market 	Central market (TSO) Local market (DSO)	Priority for the DSO
Shared Balancing Responsibility model	<ul style="list-style-type: none"> Organisation of local market Buyer of flexibility for local congestion management and balancing 	Central market (TSO) Local market (DSO)	Exclusive use for the DSO
Common TSO-DSO AS market model	<ul style="list-style-type: none"> Organisation of flexibility market in cooperation with TSO Buyer of flexibility for local congestion management 	Common market (TSO and DSO)	Minimisation of total costs of TSO and DSO
		Central market (TSO) Local market (DSO)	
Integrated Flexibility market model	<ul style="list-style-type: none"> Buyer of flexibility for local congestion management 	Common market (independent market operator)	Highest willingness to pay

The evaluation of the 5 coordination schemes is presented below, Table 2.

Table 2						
Domain	Performance criteria	Coordination scheme				
		Centralised AS market model	Local AS market model	Shared Balancing Responsibility model	Common TSO-DSO market model	Integrated Flexibility market model
Interaction between system operators	Adequacy of existing communication channels, including the	High	Medium	Medium	Low	Medium



	use of common data					
Grid operation	Respecting distribution grid constraints	Low	High	High	High	High
	Use of resources from the distribution grid by the TSO	High	Medium	Low	High	High
	Recognition of the evolving role of the DSO	Low	High	High	High	High
Market operation	Possibility to lower market operation costs	High	Low	Low	Medium	Medium
	Liquidity of the market	Medium	Low	Low	Medium	High
	Economies of scale	Medium	Low	Low	High	High

The *Centralised AS market model* outperforms the other coordination schemes in terms of easiness of implementation of the model and low-cost operation of the flexibility market. However, this model does not recognise the evolving role of the DSO and fails to guarantee that distribution grid constraints are respected. The *Local AS market model* and the Shared Balancing Responsibility model takes into account the role of the DSO and the existence of grid constraints of the distribution grid. Unfortunately, there is a risk of small illiquid markets and economies of scale are limited. The *Common TSO-DSO AS market model* and the *Integrated Flexibility market model* support mostly the liquidity of the market and the realisation of economies of scale. Nevertheless, efforts should be made with respect to communication between system operators, sharing of data and the organisation of the flexibility market in order to benefit from the full potential of these models.

2. Applicability and reproducibility

The five coordination schemes differ in terms of feasibility of implementation. Some coordination schemes are feasible today with only minor adaptations to the existing regulation and organisation of the market. Other coordination schemes require extensive modifications to the regulatory framework and market design prior to implementation.

In general, the *Centralised AS market model* is most compatible with the existing regulation and organisation of AS markets in Europe. Consequently, this coordination scheme seems to be feasible today or in the near future (2020).

An important barrier relates to the evolution of the roles of system operators. Today, the TSO has the unique responsibility to balance the system. In the *Shared Balancing Responsibility model*, this responsibility is shared with the DSO. Except for the *Centralised AS market model*, all coordination schemes assume that the DSO contracts flexibility resources to solve local grid constraints. The *Common TSO-DSO AS market model* further requires that the incentive regulation for TSOs and DSOs is adapted, in order to promote a common objective to minimise total expenses for TSOs and DSOs. In the *Local AS market model* and the *Common TSO-DSO market model* (decentralised variant), the DSO provides an aggregation function on behalf of the TSO. This is also a specific role that needs a clear definition in regulation. The evolution of roles will also require the development of the business models and tools to fulfill the responsibilities that are required by the role.

Implementation of any coordination scheme will also be affected by existing national systems of organisation and interaction among system operators. The choice of a particular coordination scheme is not only country dependent. Different coordination schemes might exist at the level of the individual product for different AS. For some AS, certain coordination schemes are irrelevant. For AS used for balancing (aFRR, mFRR, RR) or congestion management, every coordination scheme is possible. However, for AS related to frequency containment reserve (FCR) or voltage control at the transmission level, some coordination schemes could be excluded.

Coordination schemes such as the *Centralised AS market model*, the *Local AS market model* and the *Shared Balancing Responsibility model* might be easier to implement in the short term from an operational perspective. In the longer term, however, the *Common TSO-DSO AS market model* or the *Integrated Flexibility market model* might be more cost-efficient due to a higher market liquidity and more economies of scale.

D - LINK-BASED HOLISTIC ARCHITECTURE

1. Holistic model and architecture

The technical holistic model “Energy Supply Chain Net” illustrates the Links composition and their relative position in space, both horizontally and vertically, Figure 5a). In the horizontal axis, the interconnected High Voltage Grids, HVG, are arranged. They are actually owned and operated by Transmission System Operators, TSO. In the vertical axis, the Medium and Low Voltage Grids, MVG and LVG, are arranged. They are actually owned and operated by the Distribution System Operators, DSO. To include also customer plants on the vertical axis, a deeper investigation of their structure is needed. All facilities of a customer plant such as: power supplier –i.e. photovoltaic installed on the roof-; storages -i.e. electrical car battery, cooling and heating systems, etc.-; house appliances –i.e. lighting, lawnmower, etc.– are connected to each other through the internal grid of the house. Therefore, a precise definition of the prosumer as owner and operator of the customer plant facilities is derived:

Prosumer is a natural or legal person being owner of small electricity or/and storage facilities which are connected with each other through his own grid. They are connected to the power grid, but the produced electricity is mainly used to supply his own load. He is selling his electric energy surplus, and buying electric energy for its own use.

As a result, the Customer Plant Grid, CPG, is included on the vertical axis of the holistic model. Based on the specifications made above, the holistic model “Energy Supply Chain Net” is defined as follows:

“Energy Supply Chain Net” is a set of automated power grids, intended for chain links, abbreviated links, which fit into one another to establish a flexible and reliable electrical connection. Each individual link or a link-bundle operates autonomously and have contractual arrangements with other relevant boundary links or link-bundles.

The holistic model associated with the energy market is derived from the technical holistic model “Energy Supply Chain Net”, Figure 5b). This also has two axes: Horizontal and Vertical. TSOs operate on the horizontal axis of the holistic market model, while DSOs operate on the vertical one. Based on this model not only TSOs but also DSOs will communicate directly with the whole market and take over the task of load-power injection balance. The owner of the distributed energy resources and prosumers may participate directly into the whole market, or via Aggregators or Local Energy Communities, LEC.

Similar to TSO, the DSO will communicate directly with the market and operate it to ensure a congestion free distribution grid operation.

The fleshing out of the holistic models into the schematic holistic architecture requires the specification of the main, independent architecture elements. Figure 13 shows an overview of the LINK-paradigm and the deduced architecture elements. There do exist three independent

* FENIX project funded under FP6 by the European Commission

** ZUQDE project funded by “Neue Energien 2020” of “Klima- und Energiefonds”, Austria.

main power system components –i.e. Producer, Storage and Grid- that create the base for the definition of the architecture elements. The latter are defined as follows:

1. **Producer-Link** is as a composition of an electricity production facility be a generator, photovoltaic, etc., its Primary-Control and the Producer_Interface.
2. **Storage-Link** is a composition of a storage facility be the generator of a pump power plant, batteries, etc., its Primary-Control and the Producer_Interface
3. **Grid-Link** is a composition of a grid part, called Link_Grid, with the corresponding Secondary-Control and the Link_Interfaces. The Grid-Link contains secondary controls for both major entities of power systems: frequency and voltage. The secondary control algorithm should fulfil technical issues and calculate the set points by respecting dynamic constraints which are necessary for a stable and reliable operation.

The Link-Grid size is variable and is defined from the area, where the Secondary-Control is set up. Thus, a Link_Grid may apply to a customer plant, or even to a large high voltage grid area.

Thus the Link_Grid may include for e.g. one subsystem (the supplying transformer and the feeders supplied from it) or a part of the sub-transmission network, as long as the secondary control is set up on the respective area.

Each Link has its own operator. Based on the architecture elements they can be classified in three types of operators:

1. The **Producer-Link operator** operates each power plant regardless of technology and the size (excluding very small power plants, for example PV, installed on the customer side).
2. The **Storage-Link operator** operates each storage regardless of technology and the size (excluding the very small storages, for example batteries, installed on the customer side).
3. The **Grid-Link operator** operates the grid regardless of voltage level (excluding the customer grid).

Customers themselves are responsible for the operation of all their home facilities.

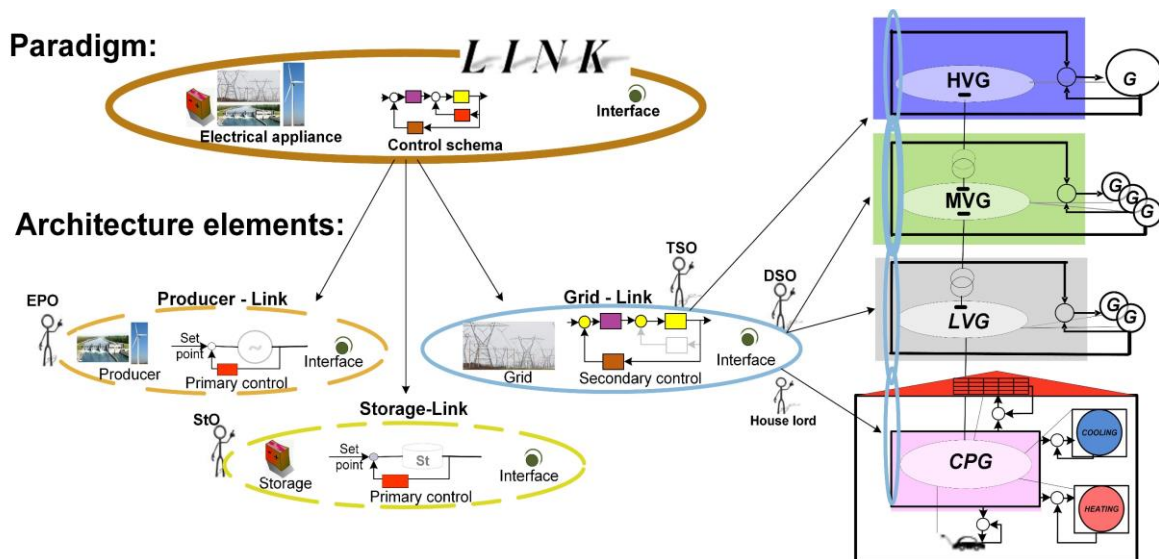

Figure 13: Overview of the LINK-paradigm and the deduced architecture elements

To overcome data privacy and cyber security challenges, the distributed LINK-based holistic architecture is chosen. Its key principle is to prohibit access to all resources by default, allowing access only to a minimum of data (see Technical details [a - Data privacy and cyber security](#) and [b - Reduction of the exchanged data](#)). Figure 14 shows the different levels of the holistic



architecture. The technical/functional level shows the conjunction of all the three architecture elements.

A standardised architecture structure goes along all voltage levels and the customer plants. The different Links communicate with each other via well-defined technical interfaces “T”, (see Technical details [c - Technical interfaces](#))

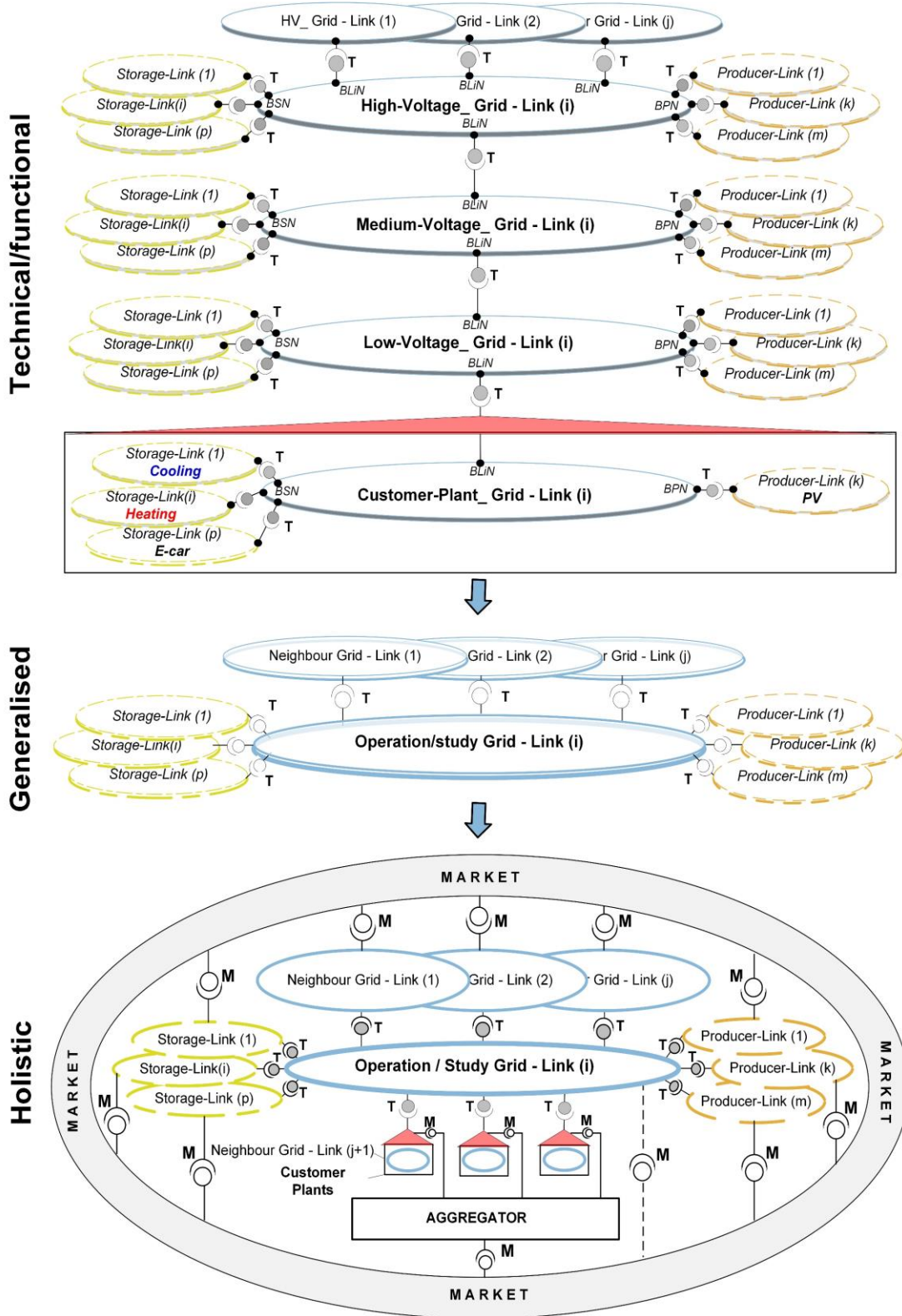

Figure 14: Different levels of the LINK-based holistic architecture



. This is a detailed architecture level facilitating all technical/functional processes which are needed to reliably and economically operate the decentralised power system. Additionally, it enables the step into the level of management systems –i.e. application level- to develop concrete applications, (see Technical details [d - Management system level](#)). The standardised structure of the technical/functional architecture allows the transition to the generalised architecture level, where the whole energy system together with the customer plants is represented very compactly. The generalised architecture is the core of the *LINK*-based holistic architecture. The market surrounds it and communicates with it through the market interfaces, “M”. In the holistic level, the Grid-Link of customer plants are taken out from the generalised presentation because they are too small to participate directly into the whole market. They may participate into the common market through the aggregators or through the LEC (see Technical details [e - LINK and local energy communities](#)). For the sake of privacy and cyber security, the technical interfaces “T” are designed apart from the market ones “M”.

Operators’ responsibility

The European Commission has required the extension of operators’ responsibility of the transmission and distribution grid in the “Clean Energies for All European’s” package, adopted at November, 30th 2016. The legislative proposals promote grid operators to procure balancing, congestion management and ancillary services from assets connected to the grid, both at the transmission and at distribution levels, on the base of cooperation among them. The establishment of the *LINK*-based holistic architecture foresees a deepening of this directive.

Each Link-operator –i.e. Producer-, Storage- or Grid-Link operator including even the customer– should operate its own Link in a safe, secure and economical manner, by respecting the contractual restrictions with neighbours.

The responsibility of the Link-operators includes metering, the submission of the relevant technical data to the neighbours through the technical interfaces, and the submission of market relevant data to all market participants through market interfaces. Additionally, each Grid-Link operator should facilitate the effectiveness and well-functioning of retail markets; have the right to use and offer services to the neighbours; have the right to dispute with neighbours to guarantee a reliable and stable operation of his Link; decide the actions should be taken for a secure and optimal operation of the own Link; be incentivised to invest in adequate solutions, beyond physical reinforcements, to increase the flexibility of the Link.

Operating modes

The new designed holistic architecture facilitates two operating modes:

1. **Autonomous** - each individual Link or Link-bundle operates independently by respecting the contractual arrangements with other relevant boundary Links or Link-bundles. All Links are connected together creating a large power system.

2. **Autarkic or self-sufficient** - is an optional operating mode, which may be applied in any Link-bundle, which consists of at least one Grid-Link and one Producer-Link or Storage-Link, as long as it is self-sufficient and -sustaining without any dependency on electricity imports.

- ♦ **Restoration** - is an option of the autarkic operating mode, which may be applied after a black out (see Technical details [f - Recovering process after a total black out](#)), during the restoration process to supply with electricity at least the communication appliances.

In order to successfully switch the operating mode from autonomous to autarkic, a familiar resynchronisation process should be established. Each Grid-Link has a secondary control on active and reactive power that supports the synchronisation process. Depending on the properties of the Links, the resynchronisation with other Links may be automatic or manual. However, the resynchronisation philosophies should be initially investigated to determine the most appropriate approach.

Technical/functional operational processes

Operators are responsible for a safe, reliable and efficient operation of the power grid at all times. To achieve these goals, they must perform a set of functions and tasks that are encapsulated in various technical/functional operational processes like: monitoring, generation-load balance, voltage assessment (see Technical details [g - Voltage assessment - violation in sub-transmission](#)), var management, static and dynamic security (see Technical details [h - Dynamic security process](#)), emergency (see Technical details [i - Emergency driven demand response](#)) and price driven demand response, etc.

The LINK-based architecture facilitates all technical/functional processes that are needed for a safe, reliable and economical operation of the decarbonised power systems of the future.

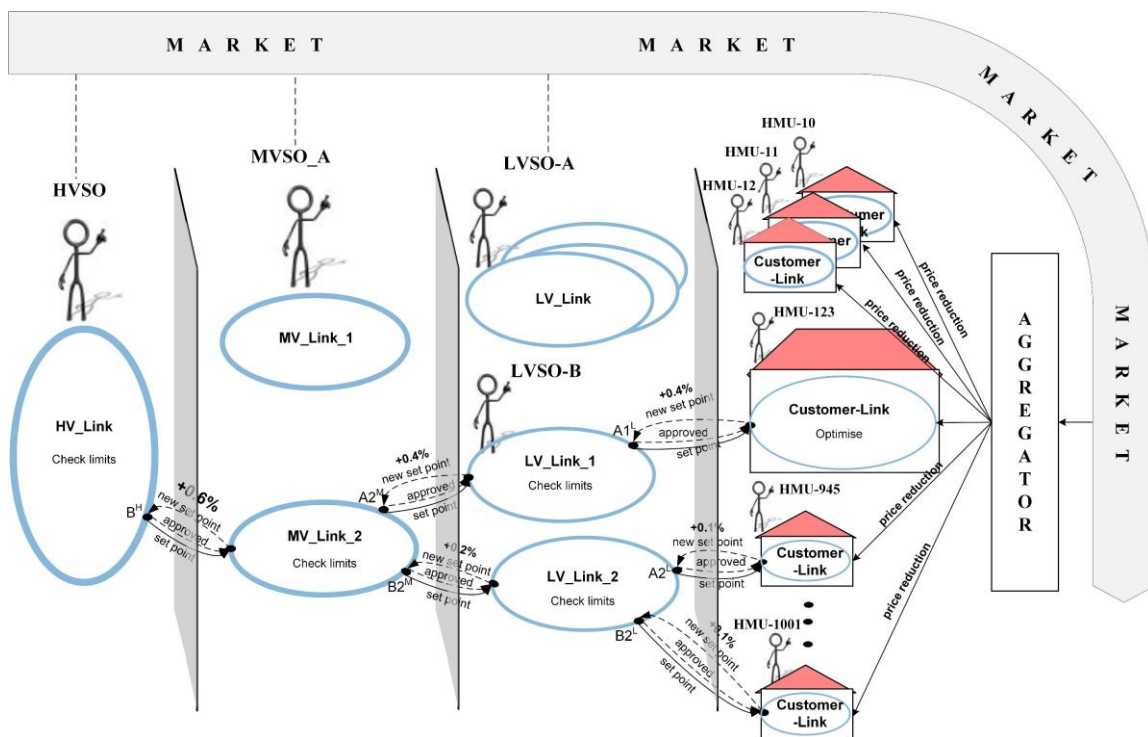

Figure 15: Overview of the price driven demand response process

This is illustrated below by describing the process of price driven demand response. The activation of the residential, commercial and small business sectors, which join the real-time pricing demand response through already concluded contracts, may be triggered at any time. Their degree of participation in the demand response process may be different depending on the time of the day, duration interval, price value, etc. In the case of a surplus of electricity in the market, the electricity price decreases. All market participants and market operators will be

notified by giving them the possibility to act on time. Figure 15 shows the information flow during the price driven demand response. This enables residential, commercial and small business sectors to perceive transparent energy prices and to contribute in the reliable and efficient operation of electric power system.

Protection

The protection relay design for the LV_ and MV_Grid-Links should be different from the one used in the past for medium and low voltage grids because Links allow the highest DER penetration and are subject to two modes of operation. One evident difference is the fact that bidirectional flows become the norm in most radial configurations. In addition, a significant change in short circuit capability occurs when Grid-Links switch from autonomous to autarkic mode of operation. The last operation mode will have a profound impact on the vast majority of protection schemas based on short-circuit current detection. In summary, the *LINK*-Protection should cover both operating modes autonomous and autarkic. In both cases, the desired protection response to a fault in the grid is to isolate the smallest area needed to eliminate it as quickly as possible.

Planning

The holistic architecture requires the close integration of operation and planning. Hence, future grid design standards, supported by appropriate regulatory framework, should recognise the added value of the *LINK*-based holistic architecture. For example, the definition of capacity in the future grid design standards should consider the ability of emergency loading of network assets because of the facilitation of the demand response process. Thus, they gain the ability to provide additional capacity in the short-term and hence, reduce the amount of demand to be interrupted. It may be cost effective to increase the life-loss of the assets by overloading these during emergency conditions, as most of the time the assets are operated below the nominal rating.

As discussed, the key issue regarding the future evolution of the electricity network design standards is associated with the question of efficiency of the operational strategies used to determine how much network capacity should be released to network users under different conditions and how advanced, non-network assets and technologies could support this capacity release. There is a clear trend in making use of advances in various technologies that can be used to provide sufficient security through a more flexible and sophisticated system operation, rather than through asset redundancy only. In this context, the implementation of the *LINK*-based holistic architecture supports the reduction of network redundancy in providing security of supply by enabling the application of a range of advanced, technically effective and economically efficient corrective (or post-fault) actions that can release latent network infrastructure capacity of the existing system. It enables higher utilisation of the existing network assets without compromising reliability of supply.

Smart cities

The electricity infrastructure is crucial for the development of Smart Cities. With its flat and standardised structure, the *LINK*-based holistic architecture provides the needed circumstances for realising and vitalising them. In Technical details [j - LINK and smart cities](#), the architecture of a Smart City district is outlined. The different Links are flexibly coupled by active and reactive power flows guaranteeing the data privacy.

The applicability

The applicability of the *LINK*-Solution is demonstrated in the field during the research project ZUQDE (Centralised Volt/var control in presence of distributed generation), in Salzburg, Austria. A part of the holistic architecture (Medium-Voltage_Grid-Link and Producer-Link)) is

successfully implemented and proofed. Its application in the Lungau test region (30kV; ≈400 km feeder length; maximal load ≈23 MW) achieved the automatic voltage and reactive power control via secondary and primary control (see Technical details [k - Load reduction](#)). Continuing this kind of operation beyond the research project duration brings many benefits to society and utilities. It enables 20% increase of decentralised generation without extension of infrastructure, reduction of capital costs for connecting distributed generation to the grid by ≈2.6 million EUROS, peak load reduction up to 6%. Thus, *LINK*-Solution supports power flow and voltage management, and hence substitute for network reinforcement, because the costs for its implementation resulted lower than network reinforcement cost.

Transition period

The upgrade of the power system architecture is compelling, but won't be built in a day – or a decade. Consequently, the upgrade process will be accompanied by a transition period with a mixed architecture. During all this time, the upgrade should be done stepwise to ensure a secure, reliable and feasible operation of the entire power system. The most important upgrade steps are presented in the following.

HVG and the power plants which are feeding to it, are the backbone of the power system which is responsible to supply the electricity with a predefined frequency and voltage. Consequently, the consolidation of the Volt/var loop in medium voltage level with well-defined constraints on the boundary with the high voltage level has the highest priority. Thereafter, the high- and the low voltage levels may be consolidated simultaneously. The consolidation of the loops concerning active power / frequency should follow the Volt/var ones.

2. Relation between automation and digitalisation

Historically, the automation concept is very old; it is introduced around 270 BC. While, the digitalisation is result of Internet Technologies developed at the beginning of the 21st century. With the emergence of computer technologies in the mid-20th century, digitisation has become an inseparable part of automation.

Different parts of power systems (for example generation) were an automation object from the beginning. Later, the introduction of SCADA and various management systems made it possible to increase the level of automation.

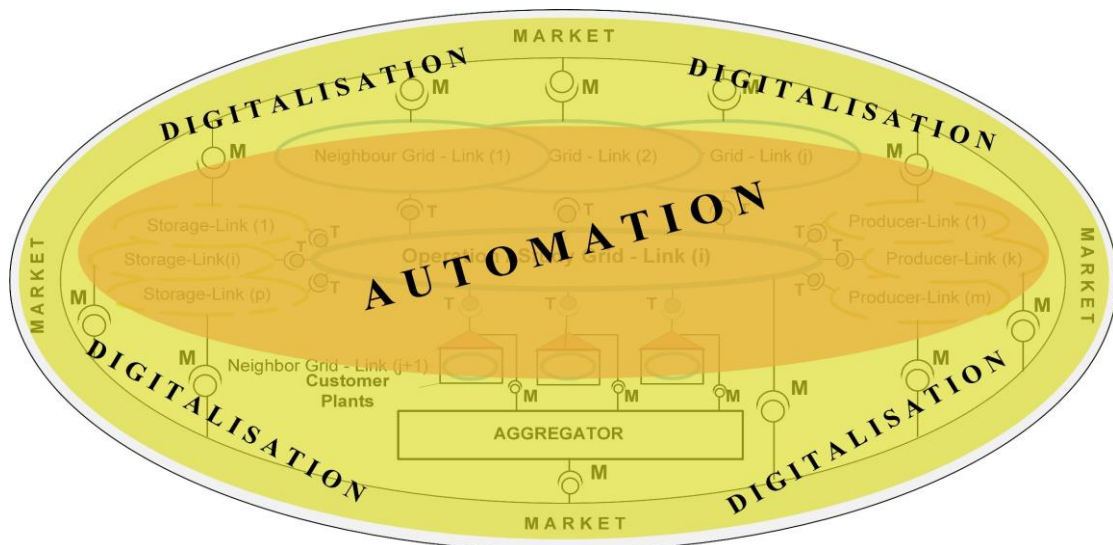

Figure 16: Overview of the application areas of automation and digitalisation techniques in the *LINK*-based holistic architecture

Automation is the core of the LINK-based holistic architecture, and a prerequisite for the successful market design and the effective implementation of digitalisation.

Nowadays, the integration of distributed generation and the extreme volatile nature of the new renewable energy sources (wind, solar) require a high automation degree of power systems and customers. **Error! Reference source not found.** shows an overview of the application areas of automation and digitalisation techniques. Automation shapes the physical behaviour of power systems, which must be followed and respected by the man-made market rules. Digitalisation is necessary, overall, to enable the active participation of customers, electricity producers and storage operators into the market.

3. LINK-Economics

The basic of the *LINK*-Economics is the functioning of available advanced technologies of management systems and optimal investment.

The available advanced technologies have undergone an intensive scientific review and have been demonstrated by the industry for both energy and distribution management systems. Therefore, there are established and reliable advanced applications that should work on some upgrades to the specifics of Links. In other words, the accumulated knowledge and the available technologies for the operation of power systems is useful to *LINK*-Solution. However, *LINK*-Solution has some unique aspects that require innovations. In general, the *LINK*-Solution differs significantly from the traditional power systems, because it consists of a set of Links that work independently together. New online and real time applications will be designed and developed to ensure reliable and resilient operation through the dynamic optimisation in each Link.

The large-scale integration of DERs and various advanced technologies enabled by *LINK*-Solution will reduce the CapEx of the future power systems. For example, the large-scale integration of DERs into the existing radial structures of medium and low voltage grids and customer plants will defer or completely avoid the cost of system extension that would otherwise be necessary to cope with the growing load. The use of the dynamic joint optimisation of demand and supply is a new opportunity on the power systems economics. In traditional energy systems, the control of loads is usually treated during the planning process and off-line analyses as demand-side management or load control associated by differentiated tariffs or contracts. LECs realised under the *LINK*-Solution behave differently. The marginal costs of own power production will be taken over at any time by the LEC-participants. In addition, LECs will have the opportunity to consider the marginal costs of energy provision at all times together with the corresponding costs for energy efficiency investments and demand reduction on the basis of demand response.

Power systems have traditionally been developed and operated to provide all customers with electricity that meets more or less the same standard of quality and reliability of power supply. *LINK*-Solution provides the ability to bring the control of power reliability and quality closer to the end user to optimise these characteristics for the respective loads. Therefore, heterogeneous standards of quality and reliability of power supply are possible, and based on and through combined economic and environmental studies, optimal investments in DERs or grid reinforcements will be identified.

With the new market design, each Link operator participates into the whole market thus enabling power trading beyond the substation and the provision of ancillary services of small entities.

4. Implementation structure

Figure 17 shows the implementation structure of the *LINK*-Solution. Based on the *LINK*-based architecture described above the following steps are necessary for its full implementation. After, the identification and the detailed specification of the use cases, based on the operational processes of power systems, the application architecture should be designed. At the same time the market design may be started. These activities should be followed by the design of the *LINK*-based ICT architecture.

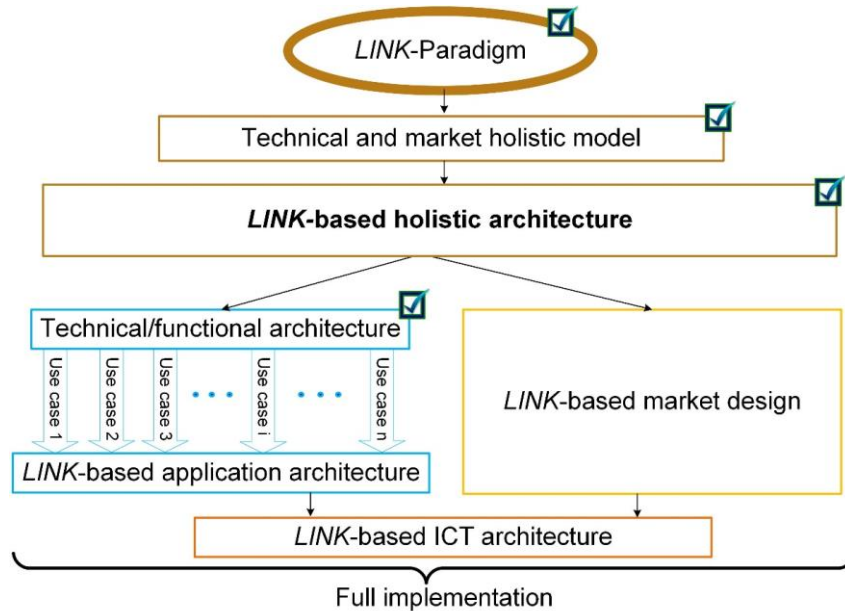

Figure 17: The implementation structure of *LINK*-Solution

5. Technical details

a - Data privacy and cyber security

The key principle of the distributed *LINK*-based holistic architecture is to prohibit access to all resources by default, allowing access only through well-defined interfaces. Thus, each Link is by definition modular and closed in itself, thus complying with GDPRs. From a cyber security perspective, a distributed control system with limited communication between its smaller

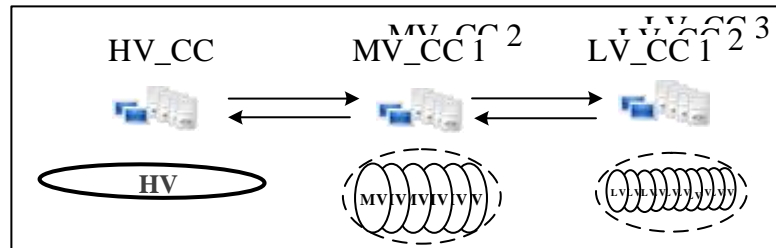

Figure 18: Power system global component base IT architecture

components is potentially more resistant to cyberattacks compared to centralised control systems that require a large amount of data exchange. The distributed *LINK*-based holistic architecture minimises the amount of data exchange by design, thereby facilitating cyber security, given the higher resilience associated with a distributed architecture. For example, these features are enhanced through the reduction of data exchanged at the TSO-DSO interface. TSO and DSO will share only a small set of electrical data with each other, which will be the minimum set of data required for the coordination of network planning and operational activities.

This holistic solution is supported by an ICT architecture that includes multi computer systems for the several voltage levels, each having their own control centre (CC), with bidirectional communication paths between HV CC and MV CC, and between MV CC and LV CC (therefore, LV CC can communicate only with MV CC, and not with HV CC), Figure 18.

b - Reduction of the exchanged data

One of the main goals of the distributed *LINK*-based architecture is the minimisation of the exchanged data. The minimised data exchange between the TSO and DSO as well as between LVG and CP are shown in the following.

- TSO-DSO level

Figure 19 shows the data flow from DSO to TSO in two cases: A) Actual power system operational architecture combined with the Grid Code [1], Figure 19a) and b), and B) Distributed *LINK*-based architecture. There are n Significant Grid Users, SGU, connected to the MVG-part that have only one connection point with the HVG. Based on [1] Article 25, each SGU shall provide three kinds of schedules: (1) the scheduled unavailability; (2) the forecasted scheduled active power output at the connection point in distribution grid and (3) any forecasted restriction in the reactive power control capability. In Article 29 are described two communication variants: firstly all schedules may be communicated by each SGU directly to the corresponding TSO and DSO, Figure 19a). Or, secondly, they may be communicated via its DSO to the TSO, Figure 19b). Therefore, TSO will receive $3 \cdot n$ schedules in both variants of case A. Figure 19c) shows the data should be changed by using the decentralised *LINK*-based architecture, case B. In this case the SGU owners should exchange the data only with the operator of the Link where they are connected. Due to the enclosed nature of the Links, the TSO shouldn't get any information about the network users, who are connected directly to the distribution grid. That means they should communicate only with the DSO. The TSO will receive the required scheduled data from the DSO. The exchanged data are the day ahead scheduled active and reactive power and the corresponding active and reactive power support $P_{\text{dayaheadSchedule}} \pm \Delta P$, $Q_{\text{dayaheadSchedule}} \pm \Delta Q$, that flow in the intersection point HV/MV; $A^H A^M$. The number of the data should be exchanged is always 4. As result, the scheduled data amount that should be exchanged in the case of the traditional architecture combined with the Grid Code increases continuously with SGU number by $3 \cdot n$, while in the case of distributed *LINK*-

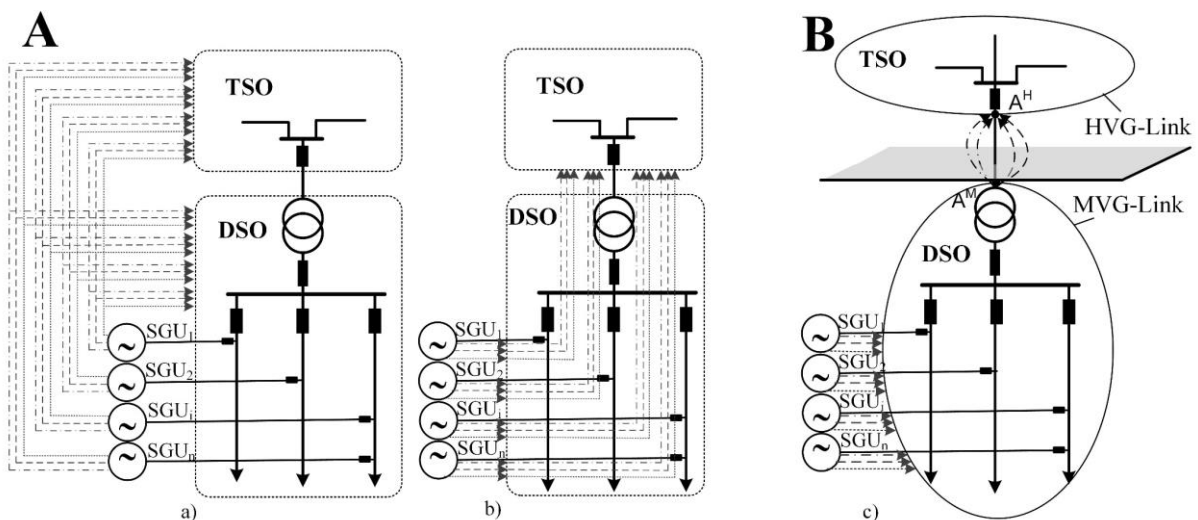

Figure 19: Data flow from DSO to TSO: a) demand facilities communicate directly to the corresponding TSO and DSO; b) demand facilities communicate via the corresponding DSO to the TSO; c) data exchange in the case of *LINK*-Solution.

based architecture the number of exchanged schedules is independent from the SGU number. It remains constant at 4.

[1] ENTSO-e homepage "Network Code on Operational Security" (24 September 2013, available from: <https://www.entsoe.eu/major-projects/network-code-development/operational-security/Pages/default.aspx>).

- LVG/CP level

The massive integration of rooftop photovoltaic facilities causes upper voltage limit violations in low-voltage grids. To eliminate these voltage violations the customer PV-inverters are upgraded with different local control strategies. Therefore, the LVG operation is intertwined with the operation of each thereto connected inverter, although the latter are the customers' property. The Q provided by the inverters depends on the feeder bus voltage where the house and hence the inverter are connected. All of the current solutions intended to prevent upper voltage limit violations cause new technical and social problems. PV inverters in $\cos\phi^{inv}(P^{inv})$ or $Q^{inv}(U^{FeederBus})$ operation mode causes an excessive reactive power flow thus increasing considerably the grid losses and transformer loading and in many cases active power curtailments are necessary to ensure the quality and reliability of supply. Their coordination provokes major ICT challenges, **Error! Reference source not found.**, and moreover their resolution is not yet foreseeable.

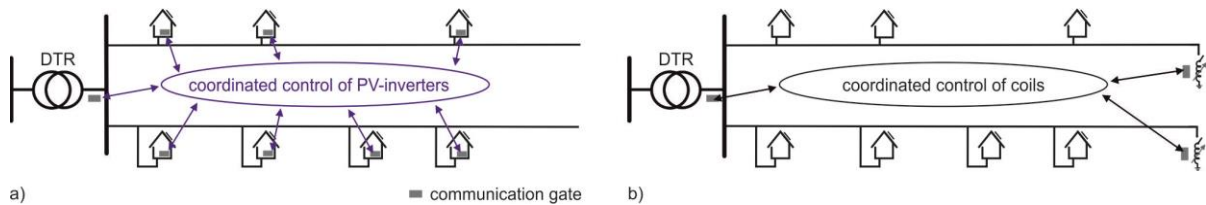

Figure 20: Schematic LVG and the required data flows for a coordination of: a) $Q(U)$; and b) $L(U)$.

Based on the *LINK*-Solution, DSO-owned inductive devices (inverter or coil) are used to alleviate voltage violations in low voltage grids, Figure 21. This control concept unbundles the operation of DSO- and customer-owned appliances, thus mitigating the aforementioned social issues. The locally controlled $L(U)$ are set at the end of the violated feeders. If coordination is required $L(U)$ needs very little data, Figure 20b).

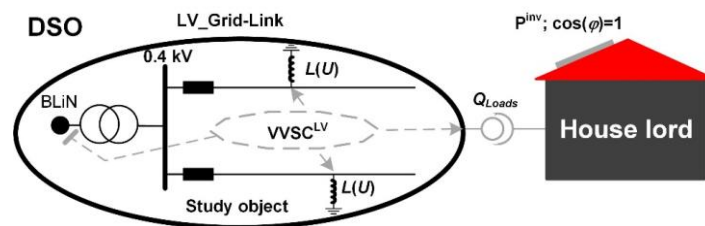

Figure 21: Overview of the LV_Grid-Link using the concentrated $L(U)$ local control strategy.



c - Technical interfaces

The exchanged information via these interfaces should enable a secure and reliable operation by means of load-generation balance, static and dynamic security, and optimisation processes for each Link. The relevant electrical entities to be exchanged for all the three types of interfaces, as Grid-Link_Grid-Link, Grid-Link_Producer-Link and Grid-Link_Storage-Link, are shown in Table 3.

Table 3
Electrical entities exchanged between different Link interface types

Electrical entities to be exchanged (*)		Between two Grid-Links	Between Grid-Link & Producer-Link (**)	Between Grid-Link & Storage-Link
Very fast	f_{meas}	√	√	√
	V_{meas}, δ_{meas}	√	√	√
	P_{meas}, Q_{meas}	√	√	√
	$P_{set_point}, Q_{set_point}$	√	√	√
Fast	$P_{des\pm\Delta P}, Q_{des\pm\Delta Q}$ Delivered time Time interval	√	√	√
	$P_{des}^{nexthour} \pm \Delta P$ $Q_{des}^{nexthour} \pm \Delta Q$	√	√	√
	$P_{Schedule}^{dayahead} \pm \Delta P$ $Q_{Schedule}^{dayahead} \pm \Delta Q$	√	√	√
	Static and dynamic (lumped) load characteristic $k_{PV}, k_{QV}, k_{Pf}, k_{Qf} \dots$	√		√
Slow	I_{equiv}, Z_{equiv}	√		
	Dynamic equivalent Generator parameters like $x_d, x'_d, \dots, T_{d0}, \dots$	√	(***)	
	Equivalent voltage regulator, static exciter parameters like K_A, T_A, \dots	√	(***)	
	Equivalent governors, turbine parameters like K_1, T_{G1}, \dots	√	(***)	√
	Schedule for demand response capability	√		√
	Reserves schedule (secondary, tertiary)	√	√	√

* data related to the boundary node

** P can have only one sign. Producers only inject power on the grid

*** static data should not be exchanged via interface

d - Management system level

Error! Reference source not found. shows how different EMS/DMS applications are integrated into a predefined operational process, the Volt/var control. The secondary control automatically controls the voltage by dynamically optimising the reactive power flow in high-

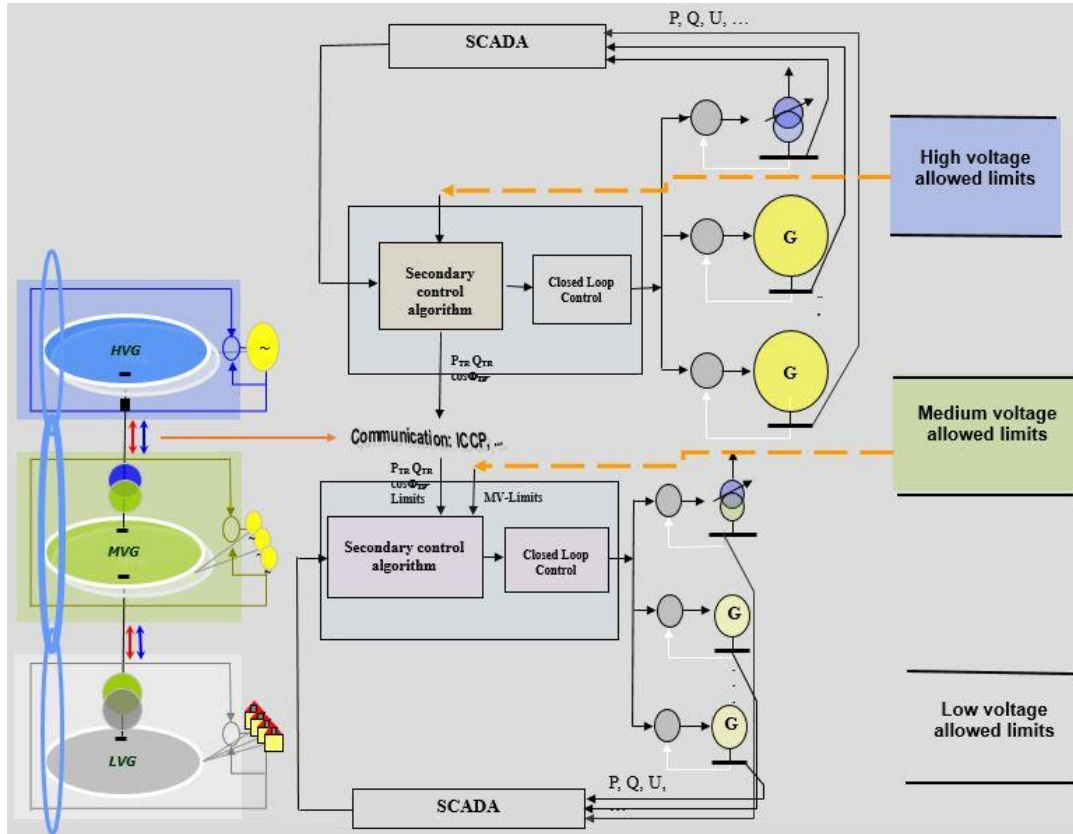

Figure 22: Overview of the secondary control loops that automatically keep the voltage within the limits and dynamically optimise the reactive power flows in high- and medium voltage levels.

and medium voltage level.

e - LINK and local energy communities

LECs are defined as: *a non-profit association, cooperative, partnership or other legal entity which is effectively controlled by local shareholders or members, to bring benefits to local communities and to represent local interests, involved in distributed generation, storage, supply, provision of energy efficiency services, aggregation, electro-mobility and distribution system operation including across borders**. Here, two relevant cases are identified: LEC with and without ownership on electrical facilities. In the first case, LEC acts as a vertically integrated company that owns and operate the distribution infrastructure, as well as DER's. In the second case, LEC does not own or operate any electric facility. DSOs and DERs owners operate their facilities on the basis of schedules approved by the corresponding LEC. *LINK*-Solution supports both cases. Figure 23 shows the embedment of an LEC without ownership on electrical facilities in the *LINK*-based holistic architecture. All market actors, including customers of local energy communities are participating in the market in a non-discriminatory way. Each market actor -i.e. simple consumers, prosumers, DER operators, and service providers- may participate in the market directly, through an aggregator or through the LEC. The latter is responsible for the local long term supply and storage planning and the corresponding coordination with the relevant DSO and with the neighbours to guarantee the reliable power supply in its own area. Based on the *LINK*-Solution, DSOs may technically comply with the schedules proposed by LECs and coordinate the operation with the relevant TSOs (in terms of ancillary services provision) using a minimum of data exchange.

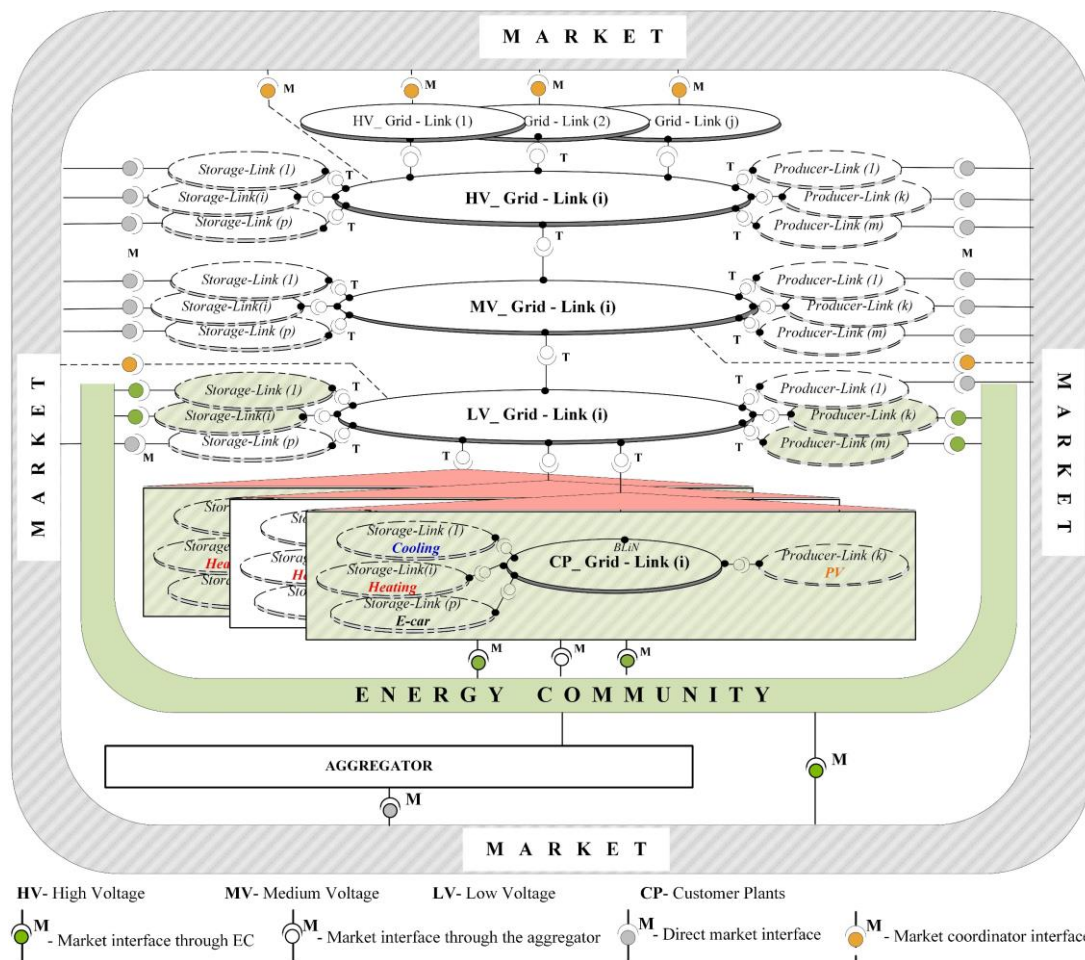

Figure 23: The embedment of a LEC without ownership on electrical facilities in the *LINK*-based holistic architecture

* Report on the proposal for a directive of the European Parliament and of the Council on common roles for the internal market in electricity, Plenary sitting A8-0044/2018, 27.2.2018, Brussels, Belgium.

f - Recovering process after a total black out

The following hypothetical case is considered. *LINK*-Solution is successfully implemented in all affected areas. All Links operate as designed. It is a sunny and hot summer day, when at 1pm a total black-out occurs. About 85% of customer plants have already installed PV systems. Distributed electricity producers and storages are installed in low and medium voltage grids.

1 pm

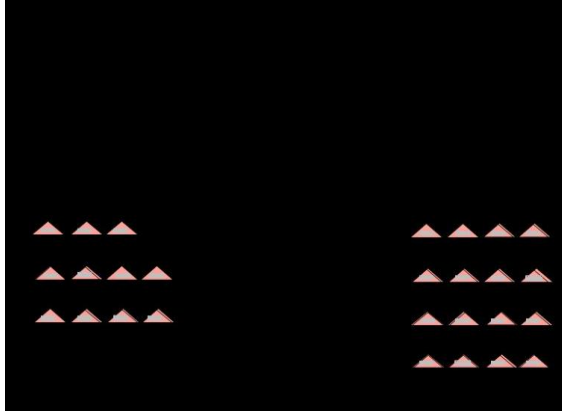

All customer plants with installed PV's have the opportunity to supply individually at least their minimal load by changing the operation from normal-autonomous to autarkic-recovery.

After 5 min

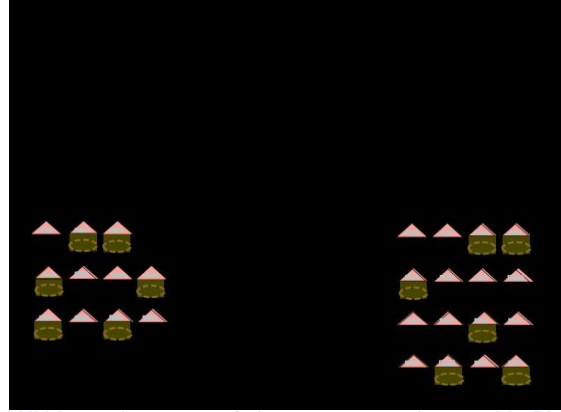

Within 5min some of the customer plants with PV have set the operation mode to autarkic-recovery and have partially supplied the load.

After 10 min

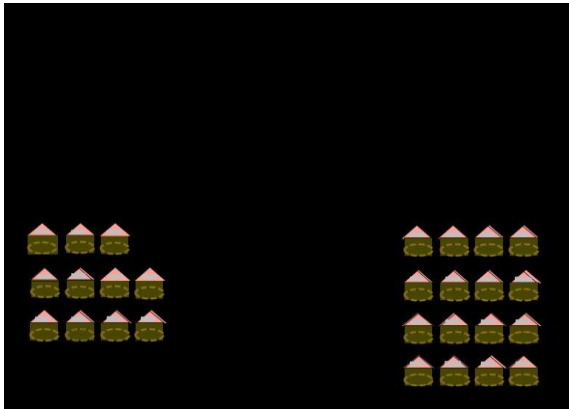

After 10min almost all of the customer plants with PV have set the operation mode to autarkic-recovery and have partially supplied the load.

After 60 min

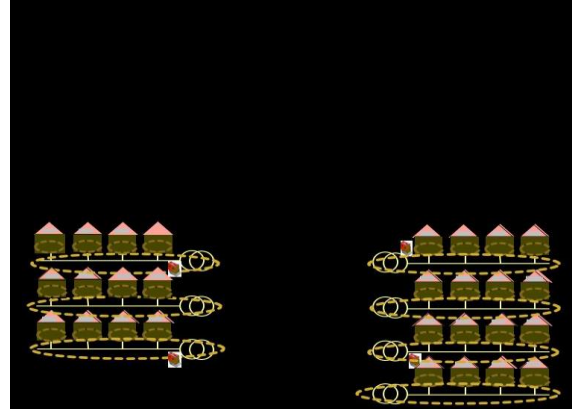

Within one hour, in each LV-Link is set the operation mode to autarkic-recovery, thus supplying partially the customer plants without PV installation.

After 120 min

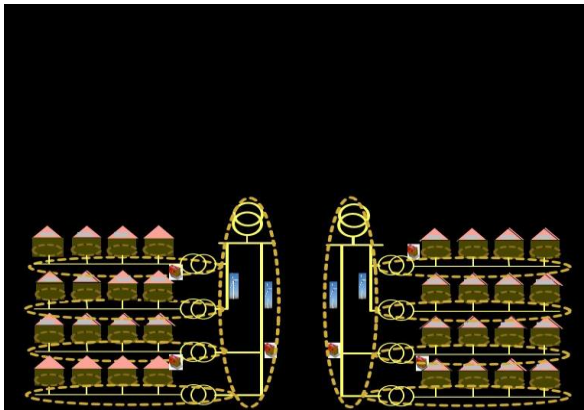

Within two hours in each MV-Link is set the operation mode to autarkic-recovery, thus supplying partially all customer plants which couldn't be supplied individually or by the LV-Links. At least the minimal load of all customers is supplied...

After a couple of hours

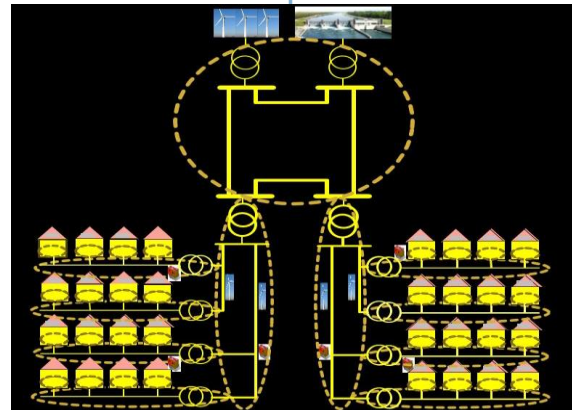

Within a couple of hours the HV-Links have recovered and the full load is supplied.

g - Voltage assessment - violation in sub-transmission grid

Error! Reference source not found. shows the use case: voltage violations in a sub-transmission grid **Error! Reference source not found.**a) shows the system operation in presence of a contingency. Voltage limit violations are discovered on the grid of HV^{Sub-Trans.}_Link. VVSC^{HV-S} application is run to find an adequate solution without violations. **Error! Reference source not found.**4b) shows the calculation of the new set points and the corresponding change request. If no any solution is found, than VVSC^{HV-S} relaxes the operation constraint on point B. The grid control variable changes the status from grid constraint to grid control variable. VVSC^{HV-S} calculates the suitable and the HV^{Sub-Trans.}_Link sends a request to the HV^{Trans.}-Link. The latter activates the VVSC^{HV-T} and updates the dynamic list grid controls. The new reactive power value on point A acts now as a constraint. VVSC^{HV-T} performs the new calculations. If results are reasonable, HV^{Trans.}-Link approves the new desired value. **Error! Reference source not found.**4c) shows the approving and setting process of the new desired set point. The same procedure is used to alleviate the violations or to optimise the operation

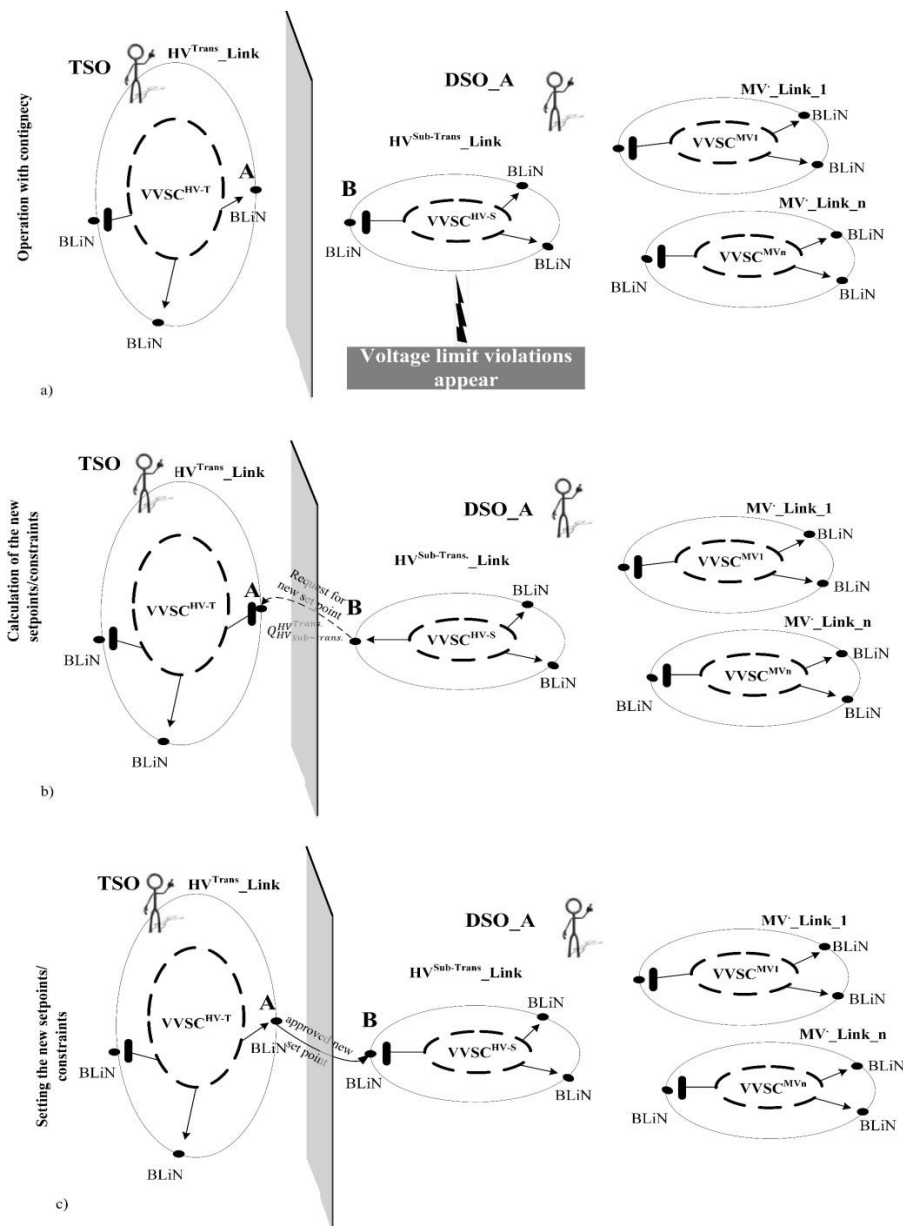

Figure 24: Use case - voltage violations in the sub-transmission grid: a) operation with contingency; b) calculation and change request of the new set-points/constraints; c) approving and setting of the new set-points/constraints.

of the other Link types (other grid parts).

h - Dynamic security process

Figure 25 shows the dynamic security process for the HV_Link when a new DG is switched-on within the grid of the MV_Link_2. Although the DG is not part of the MV_Link_2, it impacts its dynamic behaviour. Therefore, the new parameters for the dynamic equivalent generator DEG^{new} and the equivalent impedance EI^{new} related to the Boundary Link Node, $BLiN$; B^M , are calculated on line. If the new calculated values related to B^H differ from the old ones, they are committed to the HV_Link, Figure 25a). Thus, the HV_Link is notified one of the neighbours has changed its dynamic behaviour. Hence, the HV_Link operator initiates the calculation of the dynamic stability (angular and voltage) of his own Link with the updated parameters of the calculation model, Figure 25b).

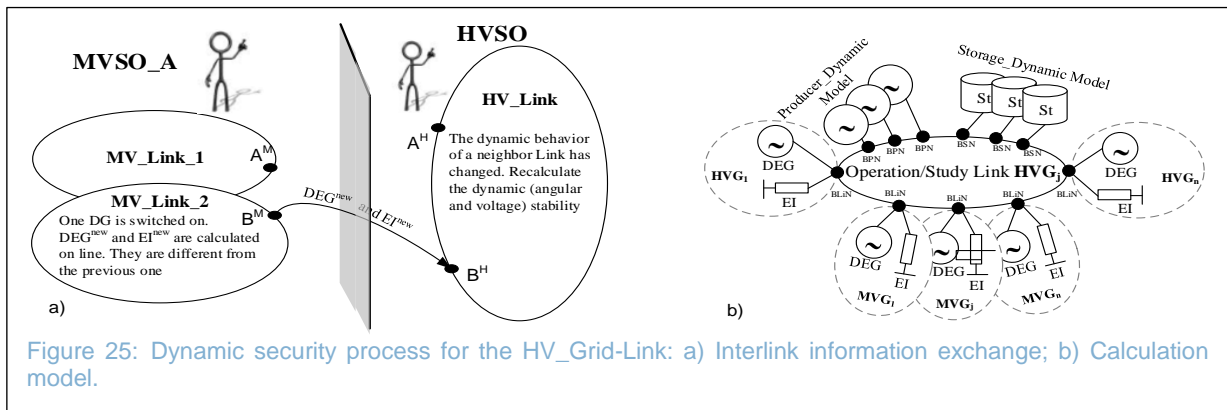

Figure 25: Dynamic security process for the HV_Grid-Link: a) Interlink information exchange; b) Calculation model.

i - Emergency driven demand response

A price signal is sent to the customer from the high through the medium and low voltage grid to encourage the customer (or LEC) development and investment in electricity production and/or load control to mitigate the congestion. **Error! Reference source not found.** shows the demand response process when an HV-line is overloaded. HVSO identifies a lightly overloaded line, where next hour is expected an increase in the overload up to 8%. By using the relevant applications, he defines the boundary nodes A^H and B^H on his grid, where the load decrease should be performed with an amount of 2 and 6%, respectively. Both Links connected at the boundary nodes are MV_Links and are operated from the same operator MVSO_A. Afterwards, HVSO initiates a demand decrease request and proposes 2 new set points, which are accompanied by the setting and duration time. After receiving the request for the new set points, MVSO_A investigates all possibilities to realise the demand decrease by using his own resources, e.g. the Conservation Voltage Reduction, CVR. The 2% reduction of the power which is injected through the boundary node A^H into the MV_Link_1 can be realised by performing the CVR on it. No other actions are needed. Therefore, MVSO_A approves the new set point. The reduction desired on the boundary node B^H is bigger than at A^H , about 6%, and only one part of it, e.g. 5.4%, can be reached by performing CVR in MV_Link_2. For the rest, about 0.6% demand reduction, other actions are necessary. After investigating his own network and the day ahead schedules, MVSO_A identifies the boundary nodes $A2^M$ and $B2^M$ as the most suitable ones, which should bring a reduction of 0.4 and 0.2%, respectively. LV_Link_1 and LV_Link_2 are connected to the boundary nodes $A2^M$ and $B2^M$, respectively. Both links are operated from the LVSO_B. Afterwards, MVSO_A initiates a demand decrease request and proposes 2 new set points, which are accompanied by the setting and duration time. After receiving the request for the new set points, LVSO_B investigates all possibilities to realise the demand decrease. He cannot perform the CVR in his own Link_Grids and therefore he should pass over the request on to the customers, who already have signed a contract for participation in "demand response" process. After performing its own calculations

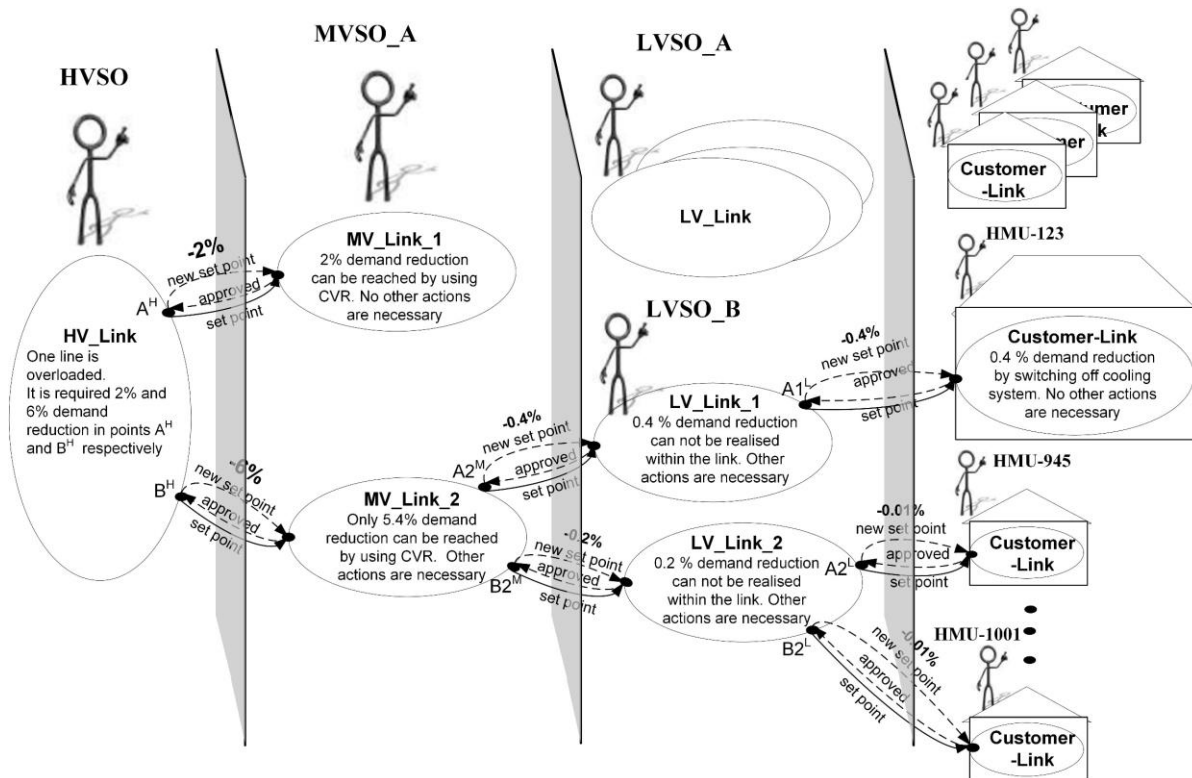

Figure 26: Emergency demand response process: line overload on high voltage grid.

LVSO_B finds three boundary nodes which are most suitable to realise the demand reduction: $A1^L$ in LV_Link_1 and $A2^L$ and $B2^L$ in LV_Link_2. Consequently, LVSO_B initiates a demand decrease request and gives over the amount of load decrease, 0.4, 0.01 and 0.01%, respectively. The request is accompanied by the setting and duration time of the new set points. HMU-123 is connected to the boundary node $A1^L$. After receiving the request for the new set point, HMU-123 investigates all possibilities to realise the demand decrease. He approves the new set point and notifies LVSO_B. The same approval and notifying procedure is used also by HMU-945 and HMU-1001. After collecting all replies, LVSO_B approves the new set points for the boundary nodes $A2^M$ and $B2^M$, and notifies MVSO_A. Having the approvals from both relevant boundary nodes, MVSO_A can fulfil the requirements in the boundary node B^H , approves the new set point and notifies the HVSO. The latter sends the ultimate set points accompanied by the setting and the duration time. MVSO_A makes the final changes on the set point schedules and sends the information further to LVSO_B. He repeats the same procedure as MVSO_A. HMUs act similarly. Thus, by supervising and controlling the fluxes at the boundary nodes, the Link_Secondary_Control enables the cross demand response through all voltage level grids up to the native load.

j - LINK and smart cities

The flexible setting of the Grid-Link size allows the easy application of LINK-Solution to the Smart City grid. Figure 27 shows the technical/functional architecture of a Smart City district.

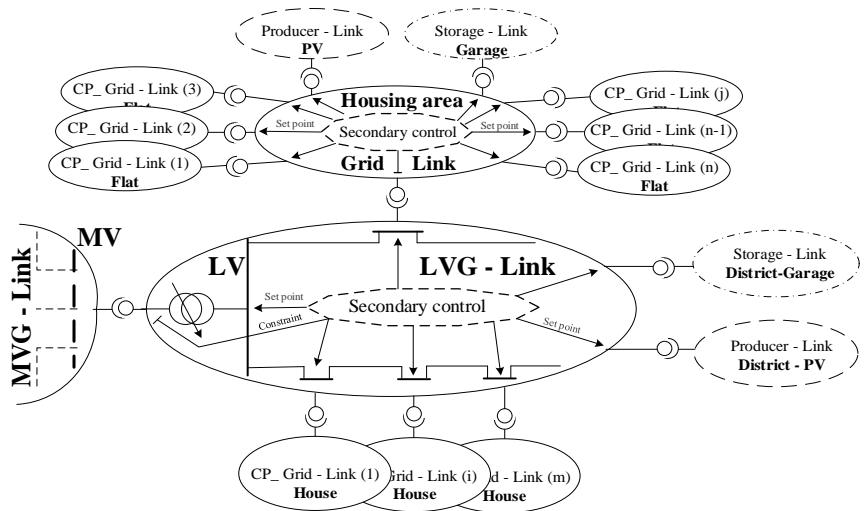

Figure 27: Technical/functional architecture of a Smart City district.

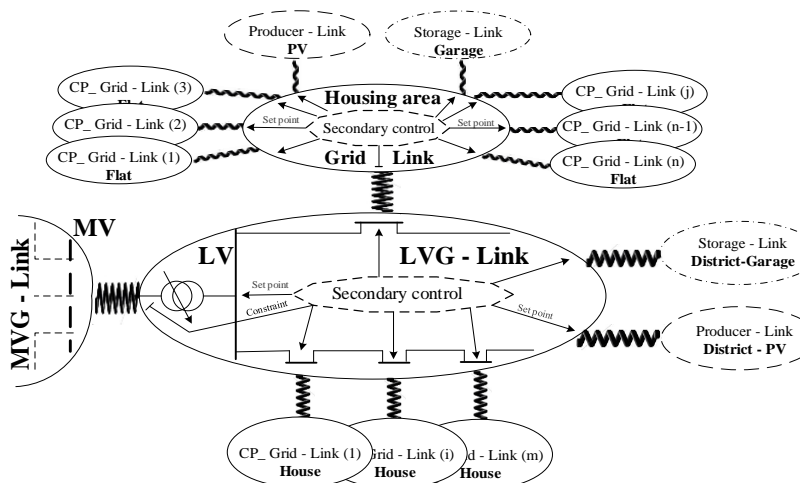

Figure 28: Resilient connection between different Links of a Smart City district.

shows the resilient connection between the different Links of a Smart City district. The dynamically controlled active and reactive power flow between different Links allows their robust and resilient interaction.

Each Link acts as a black box that exchanges a limited amount of data with other neighbouring Links, thus guaranteeing their data privacy, **Error! Reference source not found.**

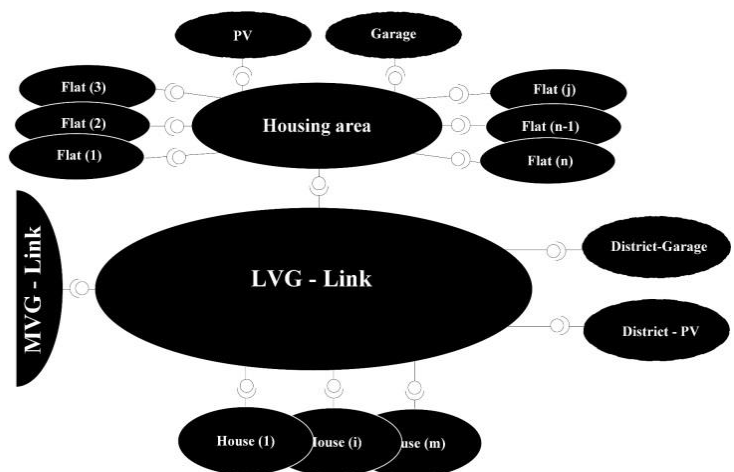

Figure 29: Data privacy of each Link is guaranteed

k - Load reduction

The MV_Grid-Link and four Producer-Links are realised in the frame of the industrial research project ZUQDE (Central Volt/var Control in presence of distributed generation), Salzburg, Austria, for one of the major entities of power systems: the voltage.

The Link_Secondary-Control was realised by means of the Volt/var control, Figure 30. Its algorithm has calculated the set points by respecting the constraint. The constraint was set to the HV/MV transformer by means of a static constraint (constant $\cos\phi$), Figure 31. The set points were sent to all four “run of river” distributed generators by means of the reactive power Q , while to the feeder head bus bar was sent the voltage set point. All relevant generators were upgraded with the primary control, thus building up the Producer-Links. All connected low voltage grids

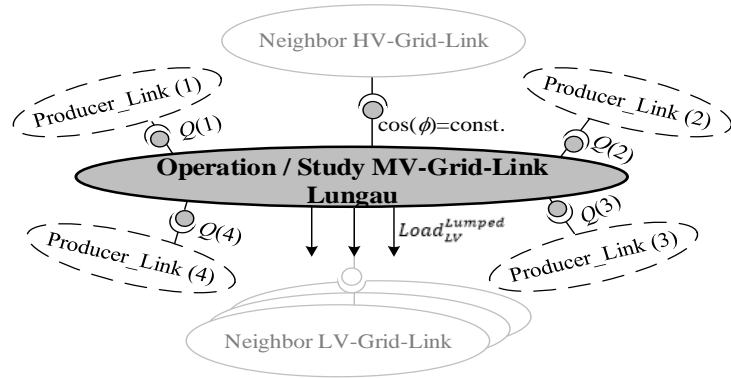

Figure 31: Realised technical/functional architecture for the Volt/var management in Lungau region.

were modelled as loads. As result, the voltage in Lungau region was automatically controlled and at once the grid was being dynamically optimised in real-time for more than one year. The load was reduced up to 7%, Figure 32.

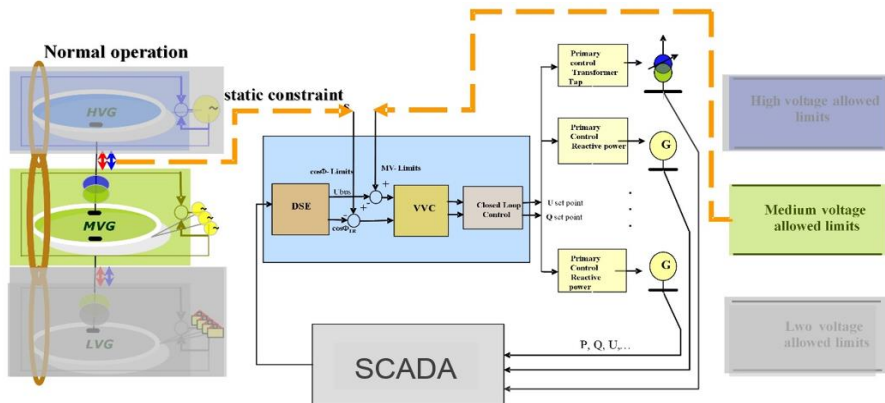
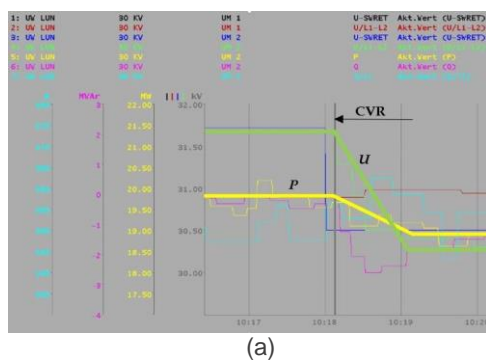

Figure 30: Practical realisation of the MV_Grid-Link and Producer-Links in management system level.

were modelled as loads. As result, the voltage in Lungau region was automatically controlled and at once the grid was being dynamically optimised in real-time for more than one year. The load was reduced up to 7%, Figure 32.



Voltage and load reduction potential				
Time	Loading case	Supplying transformer loading [MW]	Voltage reduction [%]	Load reduction [%]
Day1 15:38	average	16.7	4.33	6.53
Day1 16:00	average	17.0	4.67	7.06
Day2 21:37	minimal	9.7	4.33	4.67
Day2 22:13	night current	12.8	4.33	6.57

Figure 32: Active power reduction on HV/MV transformer level by changing-over the ZUQDE functionality. a) real time recording; b) active power reduction for different loading cases.

About ETIP-SNET

Find out more at: <https://www.etip-snet.eu>. European Technology & Innovation Platforms (ETIPs) have been created by the European Commission in the framework of the new Integrated Roadmap Strategic Energy Technology Plan (SET Plan) by bringing together all the interested and involved stakeholders and experts from the energy sector. The ETIP Smart Networks for Energy Transition (SNET) role is to provide advice on foreseeably important Research, Development & Innovation (RD&I) to support Europe's energy transition, more specifically, its mission is to:

- Set-out a vision for RD&I for Smart Networks for Energy Transition and engage stakeholders in this vision.
- Prepare and update the Strategic Research and Innovation Roadmap
- Report on the implementation of RD&I activities at European, national/regional and industrial levels.
- Provide input to the SET Plan action 4 which addresses the technical challenges raised by the transformation of the energy system.
- Identify innovation barriers, notably related to regulation and financing.
- Develop enhanced knowledge-sharing mechanisms that help bring RD&I results to deployment.
- Prepare consolidated stakeholder views on Research and Innovation to European Energy Policy initiatives.

Drafting group: Task force on holistic architectures

Albana Ilo, Ricardo Prata, Goran Strbac, Spyros Giannelos, Gareth Robert Bissell, Anna Kulmala, Norela Constantinescu, Natalie Samovich, Antonio Iliceto.

Acknowledgment

We thank all experts who greatly assisted this document:

Raphael Rinaldi, Mihaela Albu and Ilaria Losa.



ETIP SNET

EUROPEAN TECHNOLOGY AND INNOVATION PLATFORM
SMART NETWORKS FOR ENERGY TRANSITION



www.etip-snet.eu

PLAN. INNOVATE. ENGAGE.